

ALUMINIUM PROFILE M-LINE EXTRA LOW

PROLED®

PLASTIC COVERS Seite 216-218 / page 216-218

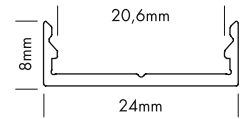

M-LINE EXTRA LOW (sehr flaches Profil)

M-LINE EXTRA LOW (very low profile)

Vier verschiedene Formen von hochwertigen Kunststoffabdeckungen stehen zur Verfügung: plan, oval, halbrund und eckig

Four different shapes of high quality plastic covers are available: flat, oval, round and square

Jede der vier Formen ist in glasklar, frost (halbkklar) und milchig frost (opal) erhältlich. Die plane Abdeckung (FLAT) wird auch in schwarz (transluzenter Effekt) angeboten.

Each of the four shapes are available in crystal clear, frost (semitransparent) and milky frost (opal). The flat cover (FLAT) is also supplied in black (translucent effect).

Auch ist die plane Abdeckung (FLAT) als begehbare und bruchfeste Variante in glasklar, frost (halbkklar) und milchig frost (opal) erhältlich.

The flat cover (FLAT) is also as a walkable and break-proof version in crystal clear, frost and milky frost (opal) available.

Mit dem LENS COVER 45° wird eine Bündelung und somit ein engerer Abstrahlwinkel erzeugt. Je nach Abstand zwischen FLEX STRIP und LENS COVER ist der Abstrahlwinkel max. 45°.

The LENS COVER 45° provides a concentration of light rays and therefore a narrower beam angle. Depending on the distance between FLEX STRIP and LENS COVER the max. beam angle is 45°.

Produkttypen / Product Type

Artikel-Nr. order code	Bezeichnung description	Länge length
L69A000	ALUMINIUM PROFILE M-LINE EXTRA LOW	2 m
L69A000X	ALUMINIUM PROFILE M-LINE EXTRA LOW	3 m
L69A000Y	ALUMINIUM PROFILE M-LINE EXTRA LOW	5 m
L69A000Z	ALUMINIUM PROFILE M-LINE EXTRA LOW	1fm (max. 5 m)* / per meter (max. 5 m)*
L69A000W	ALUMINIUM PROFILE M-LINE EXTRA LOW weiß / white**	2 m
L69A000WX	ALUMINIUM PROFILE M-LINE EXTRA LOW weiß / white**	3 m
L69A000WZ	ALUMINIUM PROFILE M-LINE EXTRA LOW weiß / white**	1fm (max. 3 m)* / per meter (max. 3 m)*

*Zuschnitt nach Maß / Custom Length

**weiß RAL 9016 / white RAL 9016

Eine Übersicht welche PROFILE mit welchen STRIPS kompatibel sind, finden Sie auf Seite 250.

For compatibility of PROFILES and STRIPS see page 250.

PLASTIC COVERS M-LINE Seite 216-218 / page 216-218

Formen shapes	Varianten versions
FLAT	CLEAR, FROST, MILKY (OPAL), BLACK
BREAK-PROOF FLAT	CLEAR, FROST, MILKY (OPAL)
OVAL	CLEAR, FROST, MILKY (OPAL)
ROUND	CLEAR, FROST, MILKY (OPAL)
SQUARE	CLEAR, FROST, MILKY (OPAL)
LENS 45°	CLEAR

ALUMINIUM PROFILE M-LINE EXTRA LOW 10

PROLED®

1.2



PLASTIC COVERS Seite 216-218 / page 216-218

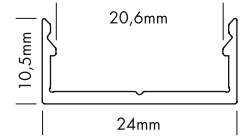

M-LINE EXTRA LOW 10 (sehr flaches Profil)

M-LINE EXTRA LOW 10 (very low profile)

Vier verschiedene Formen von hochwertigen Kunststoffabdeckungen stehen zur Verfügung: plan, oval, halbrund und eckig

Four different shapes of high quality plastic covers are available: flat, oval, round and square

Jede der vier Formen ist in glasklar, frost (halbkklar) und milchig frost (opal) erhältlich. Die plane Abdeckung (FLAT) wird auch in schwarz (transluenter Effekt) angeboten.

Each of the four shapes are available in crystal clear, frost (semitransparent) and milky frost (opal). The flat cover (FLAT) is also supplied in black (translucent effect).

Auch ist die plane Abdeckung (FLAT) als begehbare und bruchfeste Variante in glasklar, frost (halbkklar) und milchig frost (opal) erhältlich.

The flat cover (FLAT) is also as a walkable and break-proof version in crystal clear, frost and milky frost (opal) available.

Mit dem LENS COVER 45° wird eine Bündelung und somit ein engerer Abstrahlwinkel erzeugt. Je nach Abstand zwischen FLEX STRIP und LENS COVER ist der Abstrahlwinkel max. 45°.

The LENS COVER 45° provides a concentration of light rays and therefore a narrower beam angle. Depending on the distance between FLEX STRIP and LENS COVER the max. beam angle is 45°.



Produkttypen / Product Type

Artikel-Nr. order code	Bezeichnung description	Länge length
L69A001	ALUMINIUM PROFILE M-LINE EXTRA LOW 10	2 m
L69A001X	ALUMINIUM PROFILE M-LINE EXTRA LOW 10	3 m
L69A001Y	ALUMINIUM PROFILE M-LINE EXTRA LOW 10	5 m
L69A001Z	ALUMINIUM PROFILE M-LINE EXTRA LOW 10	lfm (max. 5 m)* / per meter (max. 5 m)*
L69A001W	ALUMINIUM PROFILE M-LINE EXTRA LOW 10 weiß / white**	2 m
L69A001WX	ALUMINIUM PROFILE M-LINE EXTRA LOW 10 weiß / white**	3 m
L69A001WZ	ALUMINIUM PROFILE M-LINE EXTRA LOW 10 weiß / white**	lfm (max. 3 m)* / per meter (max. 3 m)*

*Zuschnitt nach Maß / Custom Length

** weiß RAL 9016 / white RAL 9016

Eine Übersicht welche PROFILE mit welchen STRIPS kompatibel sind, finden Sie auf Seite 250.

For compatibility of PROFILES and STRIPS see page 250.

PLASTIC COVERS M-LINE Seite 216-218 / page 216-218

Formen shapes	Varianten versions
FLAT	CLEAR, FROST, MILKY (OPAL), BLACK
BREAK-PROOF FLAT	CLEAR, FROST, MILKY (OPAL)
OVAL	CLEAR, FROST, MILKY (OPAL)
ROUND	CLEAR, FROST, MILKY (OPAL)
SQUARE	CLEAR, FROST, MILKY (OPAL)
LENS 45°	CLEAR

ALUMINIUM PROFILE M-LINE EXTRA LOW 24

PROLED®

1.2

PLASTIC COVERS Seite 216-218 / page 216-218

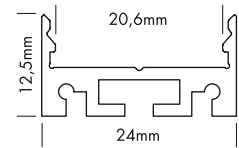

5 Years

SEE PAGE 4



M-LINE EXTRA LOW 24

Vier verschiedene Formen von hochwertigen Kunststoffabdeckungen stehen zur Verfügung: plan, oval, halbrund und eckig

M-LINE EXTRA LOW 24

Four different shapes of high quality plastic covers are available: flat, oval, round and square

Jede der vier Formen ist in glasklar, frost (halbklar) und milchig frost (opal) erhältlich. Die plane Abdeckung (FLAT) wird auch in schwarz (transluenter Effekt) angeboten.

Each of the four shapes are available in crystal clear, frost (semitransparent) and milky frost (opal). The flat cover (FLAT) is also supplied in black (translucent effect).

Auch ist die plane Abdeckung (FLAT) als begehbare und bruchfeste Variante in glasklar, frost (halbklar) und milchig frost (opal) erhältlich.

The flat cover (FLAT) is also as a walkable and break-proof version in crystal clear, frost and milky frost (opal) available.

Mit dem LENS COVER 45° wird eine Bündelung und somit ein engerer Abstrahlwinkel erzeugt. Je nach Abstand zwischen FLEX STRIP und LENS COVER ist der Abstrahlwinkel max. 45°.

The LENS COVER 45° provides a concentration of light rays and therefore a narrower beam angle. Depending on the distance between FLEX STRIP and LENS COVER the max. beam angle is 45°.

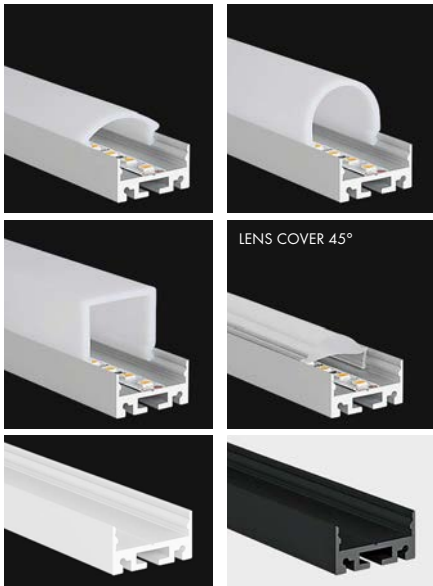

LENS COVER 45°

Produkttypen / Product Type

Artikel-Nr. order code	Bezeichnung description	Länge length
L69A002	ALUMINIUM PROFILE M-LINE EXTRA LOW 24	2 m
L69A002X	ALUMINIUM PROFILE M-LINE EXTRA LOW 24	3 m
L69A002Y	ALUMINIUM PROFILE M-LINE EXTRA LOW 24	5 m
L69A002Z	ALUMINIUM PROFILE M-LINE EXTRA LOW 24	lfm (max. 5 m)* / per meter (max. 5 m)*
L69A002W	ALUMINIUM PROFILE M-LINE EXTRA LOW 24 weiß / white**	2 m
L69A002WX	ALUMINIUM PROFILE M-LINE EXTRA LOW 24 weiß / white**	3 m
L69A002WZ	ALUMINIUM PROFILE M-LINE EXTRA LOW 24 weiß / white**	lfm (max. 3 m)* / per meter (max. 3 m)*
L69A002B	ALUMINIUM PROFILE M-LINE EXTRA LOW 24 schwarz / black***	2 m
L69A002BX	ALUMINIUM PROFILE M-LINE EXTRA LOW 24 schwarz / black***	3 m
L69A002BZ	ALUMINIUM PROFILE M-LINE EXTRA LOW 24 schwarz / black***	lfm (max. 3 m)* / per meter (max. 3 m)*
L690007	CONNECTOR 24 LINEAR	
L690008	CONNECTOR 24 90°	
L690010	CONNECTOR 24 120°	
L690011	CONNECTOR 24 135°	
L690012	CONNECTOR 24 VERTICAL 90°	
L690017	CONNECTOR 24 ADJUSTABLE (Winkel einstellbar / angle adjustable)	
L69AS3E	ALUMINIUM END CAP FLAT M-LINE EXTRA LOW 24	
L69AS3EW	ALUMINIUM END CAP FLAT M-LINE EXTRA LOW 24 weiß / white**	
L69AS3EB	ALUMINIUM END CAP FLAT M-LINE EXTRA LOW 24 schwarz / black***	
L69AR2E	ALUMINIUM END CAP ROUND M-LINE EXTRA LOW 24	
L69AR2EW	ALUMINIUM END CAP ROUND M-LINE EXTRA LOW 24 weiß / white**	
L69AR2EB	ALUMINIUM END CAP ROUND M-LINE EXTRA LOW 24 schwarz / black***	
L69AS1E	ALUMINIUM END CAP SQUARE M-LINE EXTRA LOW 24	
L69AS1EW	ALUMINIUM END CAP SQUARE M-LINE EXTRA LOW 24 weiß / white**	
L69AS1EB	ALUMINIUM END CAP SQUARE M-LINE EXTRA LOW 24 schwarz / black***	
L69AL45E	ALUMINIUM END CAP LENS 45° M-LINE EXTRA LOW 24	
L69AL45EW	ALUMINIUM END CAP LENS 45° M-LINE EXTRA LOW 24 weiß / white**	
L69AL45EB	ALUMINIUM END CAP LENS 45° M-LINE EXTRA LOW 24 schwarz / black***	

* Zuschnitt nach Maß / Custom Length ** weiß RAL 9016 / white RAL 9016 *** schwarz ähnlich RAL 9005 / black similar to RAL 9005

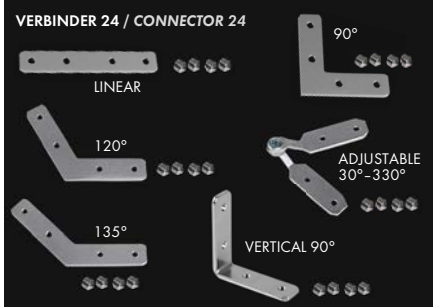

VERBINDER 24 / CONNECTOR 24

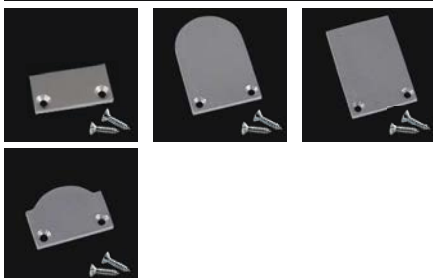

Eine Übersicht welche PROFILE mit welchen STRIPS kompatibel sind, finden Sie auf Seite 250.

For compatibility of PROFILES and STRIPS see page 250.

PLASTIC COVERS M-LINE Seite 216-218 / page 216-218

Formen shapes	Varianten versions
FLAT	CLEAR, FROST, MILKY (OPAL), BLACK
BREAK-PROOF FLAT	CLEAR, FROST, MILKY (OPAL)
OVAL	CLEAR, FROST, MILKY (OPAL)
ROUND	CLEAR, FROST, MILKY (OPAL)
SQUARE	CLEAR, FROST, MILKY (OPAL)
LENS 45°	CLEAR

ALUMINIUM PROFILE M-LINE LOW

PROLED®

1.2



PLASTIC COVERS Seite 216-218 / page 216-218

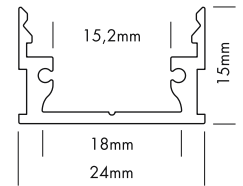

M-LINE LOW (flaches Profil)

Vier verschiedene Formen von hochwertigen Kunststoffabdeckungen stehen zur Verfügung: plan, oval, halbrund und eckig

Jede der vier Formen ist in glasklar, frost (halbkklar) und milchig frost (opal) erhältlich. Die plane Abdeckung (FLAT) wird auch in schwarz (transluenter Effekt) angeboten.

Auch ist die plane Abdeckung (FLAT) als begehbare und bruchfeste Variante in glasklar, frost (halbkklar) und milchig frost (opal) erhältlich.

Mit dem LENS COVER 45° wird eine Bündelung und somit ein engerer Abstrahlwinkel erzeugt. Je nach Abstand zwischen FLEX STRIP und LENS COVER ist der Abstrahlwinkel max. 45°.

M-LINE LOW (low profile)

Four different shapes of high quality plastic covers are available: flat, oval, round and square

Each of the four shapes are available in crystal clear, frost (semitransparent) and milky frost (opal). The flat cover (FLAT) is also supplied in black (translucent effect).

The flat cover (FLAT) is also as a walkable and break-proof version in crystal clear, frost and milky frost (opal) available.

The LENS COVER 45° provides a concentration of light rays and therefore a narrower beam angle. Depending on the distance between FLEX STRIP and LENS COVER the max. beam angle is 45°.

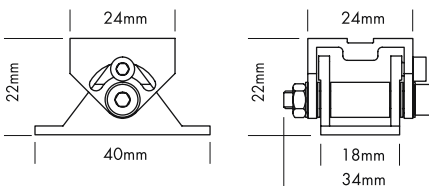

Produkttypen / Product Type

Artikel-Nr. order code	Bezeichnung description	Länge length
L69B000	ALUMINIUM PROFILE M-LINE LOW	2 m
L69B000X	ALUMINIUM PROFILE M-LINE LOW	3 m
L69B000Y	ALUMINIUM PROFILE M-LINE LOW	5 m
L69B000Z	ALUMINIUM PROFILE M-LINE LOW	lfm (max. 5 m)* / per meter (max. 5 m)*
L69B000W	ALUMINIUM PROFILE M-LINE LOW weiß / white**	2 m
L69B000WX	ALUMINIUM PROFILE M-LINE LOW weiß / white**	3 m
L69B000WZ	ALUMINIUM PROFILE M-LINE LOW weiß / white**	lfm (max. 3 m)* / per meter (max. 3 m)*
L69B000B	ALUMINIUM PROFILE M-LINE LOW schwarz / black***	2 m
L69B000BX	ALUMINIUM PROFILE M-LINE LOW schwarz / black***	3 m
L69B000BZ	ALUMINIUM PROFILE M-LINE LOW schwarz / black***	lfm (max. 3 m)* / per meter (max. 3 m)*
L69BS3E	ALUMINIUM END CAP FLAT M-LINE LOW	
L69BS3EW	ALUMINIUM END CAP FLAT M-LINE LOW weiß / white**	
L69BS3EB	ALUMINIUM END CAP FLAT M-LINE LOW schwarz / black***	
L69BR2E	ALUMINIUM END CAP ROUND M-LINE LOW	
L69BR2EW	ALUMINIUM END CAP ROUND M-LINE LOW weiß / white**	
L69BR2EB	ALUMINIUM END CAP ROUND M-LINE LOW schwarz / black***	
L69BS1E	ALUMINIUM END CAP SQUARE M-LINE LOW	
L69BS1EW	ALUMINIUM END CAP SQUARE M-LINE LOW weiß / white**	
L69BS1EB	ALUMINIUM END CAP SQUARE M-LINE LOW schwarz / black***	
L69BL45E	ALUMINIUM END CAP LENS 45° M-LINE LOW	
L69BL45EW	ALUMINIUM END CAP LENS 45° M-LINE LOW weiß / white**	
L69BL45EB	ALUMINIUM END CAP LENS 45° M-LINE LOW schwarz / black***	
L690006	ALUMINIUM SCHWENKHALTER silber 1 Stück ALUMINIUM SWIVELLING HOLDER silver 1 pcs	
L690006W	ALUMINIUM SCHWENKHALTER weiß** 1 Stück ALUMINIUM SWIVELLING HOLDER white** 1 pcs	
L690006B	ALUMINIUM SCHWENKHALTER schwarz*** 1 Stück ALUMINIUM SWIVELLING HOLDER black*** 1 pcs	
L690001	ALUMINIUM PROFILE SET MOUNTING M-LINE STANDARD + LOW / O-LINE Set bestehend aus: 3x Mounting Clip + 1x Innensechskantschlüssel Set includes: 3x Mounting Clip + 1x Allen Key	
L690001W	ALUMINIUM PROFILE SET MOUNTING weiß / white** M-LINE STANDARD + LOW / O-LINE Set bestehend aus: 3x Mounting Clip + 1x Innensechskantschlüssel Set includes: 3x Mounting Clip + 1x Allen Key	
L690001B	ALUMINIUM PROFILE SET MOUNTING schwarz / black*** M-LINE STANDARD + LOW / O-LINE Set bestehend aus: 3x Mounting Clip + 1x Innensechskantschlüssel Set includes: 3x Mounting Clip + 1x Allen Key	

*Zuschnitt nach Maß / Custom Length ** weiß RAL 9016 / white RAL 9016 *** schwarz ähnlich RAL 9005 / black similar to RAL 9005

PLASTIC COVERS M-LINE Seite 216-218 / page 216-218

Formen shapes	Varianten versions
FLAT	CLEAR, FROST, MILKY (OPAL), BLACK
BREAK-PROOF FLAT	CLEAR, FROST, MILKY (OPAL)
OVAL	CLEAR, FROST, MILKY (OPAL)
ROUND	CLEAR, FROST, MILKY (OPAL)
SQUARE	CLEAR, FROST, MILKY (OPAL)
LENS 45°	CLEAR

Eine Übersicht welche PROFILE mit welchen STRIPS kompatibel sind, finden Sie auf Seite 250.

For compatibility of PROFILES and STRIPS see page 250.

ALUMINIUM PROFILE M-LINE STANDARD

PROLED®

PLASTIC COVERS Seite 216-218 / page 216-218

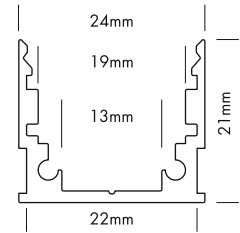

M-LINE STANDARD

Vier verschiedene Formen von hochwertigen Kunststoffabdeckungen stehen zur Verfügung: plan (nicht für DMX STRIP 30 geeignet), oval, halbrund und eckig

Jede der vier Formen ist in glasklar, frost (halbklar) und milchig frost (opal) erhältlich. Die plane Abdeckung (FLAT) wird auch in schwarz (transluenter Effekt) angeboten.

Auch ist die plane Abdeckung (FLAT) als begehbare und bruchfeste Variante in glasklar, frost (halbklar) und milchig frost (opal) erhältlich.

M-LINE STANDARD

Four different shapes of high quality plastic covers are available: flat (not suitable for the DMX STRIP 30), oval, round and square

Each of the four shapes are available in crystal clear, frost (semitransparent) and milky frost (opal). The flat cover (FLAT) is also supplied in black (translucent effect).

The flat cover (FLAT) is also as a walkable and break-proof version in crystal clear, frost and milky frost (opal) available.

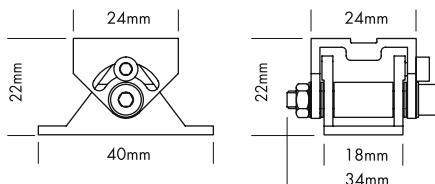
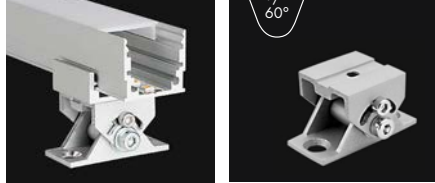
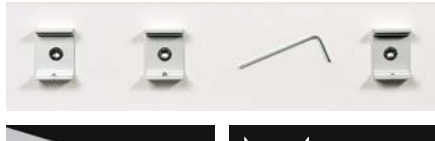
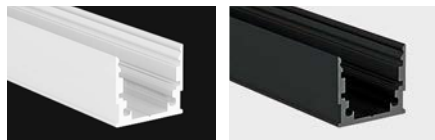

Produkttypen / Product Type

Artikel-Nr. order code	Bezeichnung description	Länge length
L690000	ALUMINIUM PROFILE M-LINE STANDARD	2 m
L690000X	ALUMINIUM PROFILE M-LINE STANDARD	3 m
L690000Y	ALUMINIUM PROFILE M-LINE STANDARD	5 m
L690000Z	ALUMINIUM PROFILE M-LINE STANDARD	1fm (max. 5 m)* / per meter (max. 5 m)*
L690000W	ALUMINIUM PROFILE M-LINE STANDARD weiß / white**	2 m
L690000WX	ALUMINIUM PROFILE M-LINE STANDARD weiß / white**	3 m
L690000WZ	ALUMINIUM PROFILE M-LINE STANDARD weiß / white**	1fm (max. 3 m)* / per meter (max. 3 m)*
L690000B	ALUMINIUM PROFILE M-LINE STANDARD schwarz / black***	2 m
L690000BX	ALUMINIUM PROFILE M-LINE STANDARD schwarz / black***	3 m
L690000BZ	ALUMINIUM PROFILE M-LINE STANDARD schwarz / black***	1fm (max. 3 m)* / per meter (max. 3 m)*
L690SBS	ALUMINIUM SLIDING BASE M-LINE	2 m
L690SBSZ	ALUMINIUM SLIDING BASE M-LINE	1fm (max. 2 m)* / per meter (max. 2 m)*
L690SBSW	ALUMINIUM SLIDING BASE M-LINE weiß / white**	2 m
L690SBSWZ	ALUMINIUM SLIDING BASE M-LINE weiß / white**	1fm (max. 2 m)* / per meter (max. 2 m)*
L690SBSB	ALUMINIUM SLIDING BASE M-LINE schwarz / black***	2 m
L690SBSBZ	ALUMINIUM SLIDING BASE M-LINE schwarz / black***	1fm (max. 2 m)* / per meter (max. 2 m)*
L690S3E	ALUMINIUM END CAP FLAT M-LINE STANDARD	
L690S3EW	ALUMINIUM END CAP FLAT M-LINE STANDARD weiß / white**	
L690S3EB	ALUMINIUM END CAP FLAT M-LINE STANDARD schwarz / black***	
L690R2E	ALUMINIUM END CAP ROUND M-LINE STANDARD	
L690R2EW	ALUMINIUM END CAP ROUND M-LINE STANDARD weiß / white**	
L690R2EB	ALUMINIUM END CAP ROUND M-LINE STANDARD schwarz / black***	
L690S1E	ALUMINIUM END CAP SQUARE M-LINE STANDARD	
L690S1EW	ALUMINIUM END CAP SQUARE M-LINE STANDARD weiß / white**	
L690S1EB	ALUMINIUM END CAP SQUARE M-LINE STANDARD schwarz / black***	
L690006	ALUMINIUM SCHWENKHALTER silber 1 Stück ALUMINIUM SWIVELLING HOLDER silver 1 pcs	
L690006W	ALUMINIUM SCHWENKHALTER weiß** 1 Stück ALUMINIUM SWIVELLING HOLDER white** 1 pcs	
L690006B	ALUMINIUM SCHWENKHALTER schwarz*** 1 Stück ALUMINIUM SWIVELLING HOLDER black*** 1 pcs	
L690001	ALUMINIUM PROFILE SET MOUNTING M-LINE STANDARD + LOW / O-LINE Set bestehend aus: 3x Mounting Clip + 1x Innensechskantschlüssel Set includes: 3x Mounting Clip + 1x Allen Key	
L690001W	ALUMINIUM PROFILE SET MOUNTING weiß / white** M-LINE STANDARD + LOW / O-LINE Set bestehend aus: 3x Mounting Clip + 1x Innensechskantschlüssel Set includes: 3x Mounting Clip + 1x Allen Key	
L690001B	ALUMINIUM PROFILE SET MOUNTING schwarz / black*** M-LINE STANDARD + LOW / O-LINE Set bestehend aus: 3x Mounting Clip + 1x Innensechskantschlüssel Set includes: 3x Mounting Clip + 1x Allen Key	

*Zuschnitt nach Maß / Custom Length **weiß RAL 9016 / white RAL 9016 ***schwarz ähnlich RAL 9005 / black similar to RAL 9005

PLASTIC COVERS M-LINE Seite 216-218 / page 216-218

Formen shapes	Varianten versions
FLAT	CLEAR, FROST, MILKY (OPAL), BLACK
BREAK-PROOF FLAT	CLEAR, FROST, MILKY (OPAL)
OVAL	CLEAR, FROST, MILKY (OPAL)
ROUND	CLEAR, FROST, MILKY (OPAL)
SQUARE	CLEAR, FROST, MILKY (OPAL)

Eine Übersicht welche PROFILE mit welchen STRIPS kompatibel sind, finden Sie auf Seite 250.

For compatibility of PROFILES and STRIPS see page 250.

ALUMINIUM PROFILE M-LINE STANDARD 24

PROLED®

1.2



PLASTIC COVERS Seite 216-218 / page 216-218

5 Years

SEE PAGE 4

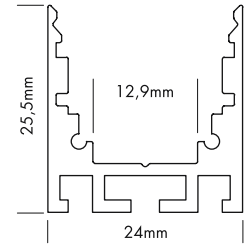

M-LINE STANDARD 24

Vier verschiedene Formen von hochwertigen Kunststoff-abdeckungen stehen zur Verfügung: plan (nicht für DMX STRIP 30 geeignet), oval, halb-rund und eckig

Jede der vier Formen ist in glasklar, frost (halbkklar) und milchig frost (opal) erhältlich. Die plane Abdeckung (FLAT) wird auch in schwarz (transluenter Effekt) angeboten.

Auch ist die plane Abdeckung (FLAT) als begehbare und bruchfeste Variante in glasklar, frost (halbkklar) und milchig frost (opal) erhältlich.

M-LINE STANDARD 24

Four different shapes of high quality plastic covers are available: flat (not suitable for the DMX STRIP 30), oval, round and square

Each of the four shapes are available in crystal clear, frost (semitransparent) and milky frost (opal). The flat cover (FLAT) is also supplied in black (translucent effect).

The flat cover (FLAT) is also as a walkable and break-proof version in crystal clear, frost and milky frost (opal) available.

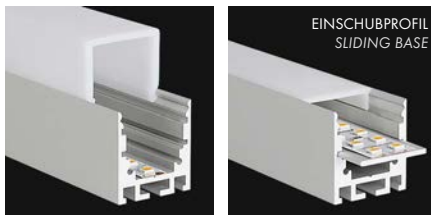
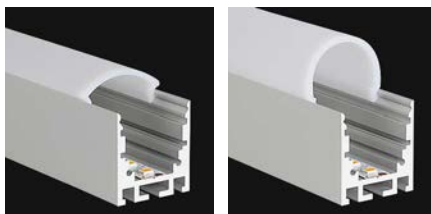

EINSCHUBPROFIL
SLIDING BASE



Produkttypen / Product Type

Artikel-Nr. order code	Bezeichnung description	Länge length
L690200	ALUMINIUM PROFILE M-LINE STANDARD 24	2 m
L690200X	ALUMINIUM PROFILE M-LINE STANDARD 24	3 m
L690200Y	ALUMINIUM PROFILE M-LINE STANDARD 24	5 m
L690200Z	ALUMINIUM PROFILE M-LINE STANDARD 24	lfm (max. 5 m)* / per meter (max. 5 m)*
L690200W	ALUMINIUM PROFILE M-LINE STANDARD 24 weiß / white**	2 m
L690200WX	ALUMINIUM PROFILE M-LINE STANDARD 24 weiß / white**	3 m
L690200WZ	ALUMINIUM PROFILE M-LINE STANDARD 24 weiß / white**	lfm (max. 3 m)* / per meter (max. 3 m)*
L690200B	ALUMINIUM PROFILE M-LINE STANDARD 24 schwarz / black***	2 m
L690200BX	ALUMINIUM PROFILE M-LINE STANDARD 24 schwarz / black***	3 m
L690200BZ	ALUMINIUM PROFILE M-LINE STANDARD 24 schwarz / black***	lfm (max. 3 m)* / per meter (max. 3 m)*
L690SBS	ALUMINIUM SLIDING BASE M-LINE	2 m
L690SBSZ	ALUMINIUM SLIDING BASE M-LINE	lfm (max. 2 m)* / per meter (max. 2 m)*
L690SBSW	ALUMINIUM SLIDING BASE M-LINE weiß / white**	2 m
L690SBSWZ	ALUMINIUM SLIDING BASE M-LINE weiß / white**	lfm (max. 2 m)* / per meter (max. 2 m)*
L690SBSB	ALUMINIUM SLIDING BASE M-LINE schwarz / black***	2 m
L690SBSBZ	ALUMINIUM SLIDING BASE M-LINE schwarz / black***	lfm (max. 2 m)* / per meter (max. 2 m)*
L690007	CONNECTOR 24 LINEAR	
L690008	CONNECTOR 24 90°	
L690010	CONNECTOR 24 120°	
L690011	CONNECTOR 24 135°	
L690012	CONNECTOR 24 VERTICAL 90°	
L690017	CONNECTOR 24 ADJUSTABLE (Winkel einstellbar / angle adjustable)	
L6902S3E	ALUMINIUM END CAP FLAT M-LINE STANDARD 24	
L6902S3EW	ALUMINIUM END CAP FLAT M-LINE STANDARD 24 weiß / white**	
L6902S3EB	ALUMINIUM END CAP FLAT M-LINE STANDARD 24 schwarz / black***	
L6902R2E	ALUMINIUM END CAP ROUND M-LINE STANDARD 24	
L6902R2EW	ALUMINIUM END CAP ROUND M-LINE STANDARD 24 weiß / white**	
L6902R2EB	ALUMINIUM END CAP ROUND M-LINE STANDARD 24 schwarz / black***	
L6902S1E	ALUMINIUM END CAP SQUARE M-LINE STANDARD 24	
L6902S1EW	ALUMINIUM END CAP SQUARE M-LINE STANDARD 24 weiß / white**	
L6902S1EB	ALUMINIUM END CAP SQUARE M-LINE STANDARD 24 schwarz / black***	

*Zuschnitt nach Maß / Custom Length **weiß RAL 9016 / white RAL 9016 ***schwarz ähnlich RAL 9005 / black similar to RAL 9005

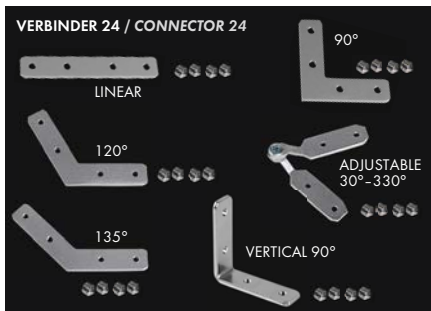

Eine Übersicht welche PROFILE mit welchen STRIPS kompatibel sind, finden Sie auf Seite 250.

For compatibility of PROFILES and STRIPS see page 250.

PLASTIC COVERS M-LINE Seite 216-218 / page 216-218

Formen shapes	Varianten versions
FLAT	CLEAR, FROST, MILKY (OPAL), BLACK
BREAK-PROOF FLAT	CLEAR, FROST, MILKY (OPAL)
OVAL	CLEAR, FROST, MILKY (OPAL)
ROUND	CLEAR, FROST, MILKY (OPAL)
SQUARE	CLEAR, FROST, MILKY (OPAL)

ALUMINIUM PROFILE M-LINE REC

PROLED®

PLASTIC COVERS Seite 216-218 / page 216-218

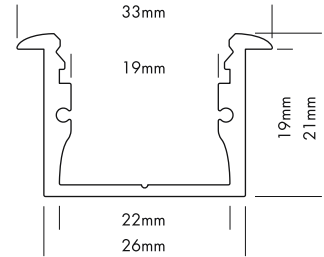

M-LINE REC (zum Wand- oder Deckeneinbau)

M-LINE REC (for wall or ceiling integration)

Vier verschiedene Formen von hochwertigen Kunststoffabdeckungen stehen zur Verfügung: plan (nicht für DMX STRIP 30 geeignet), oval, halbrund und eckig

Four different shapes of high quality plastic covers are available: flat (not suitable for the DMX STRIP 30), oval, round and square

Jede der vier Formen ist in glasklar, frost (halbkklar) und milchig frost (opal) erhältlich. Die plane Abdeckung (FLAT) wird auch in schwarz (transluzenter Effekt) angeboten.

Each of the four shapes are available in crystal clear, frost (semitransparent) and milky frost (opal). The flat cover (FLAT) is also supplied in black (translucent effect).

Auch ist die plane Abdeckung (FLAT) als begehbare und bruchfeste Variante in glasklar, frost (halbkklar) und milchig frost (opal) erhältlich.

The flat cover (FLAT) is also as a walkable and break-proof version in crystal clear, frost and milky frost (opal) available.

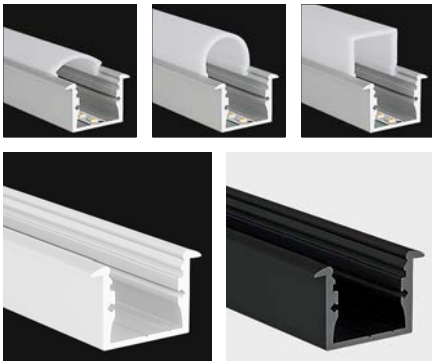

Mit Brandschutz / with fire restrictions

Ohne Brandschutz / without fire restrictions



Produkttypen / Product Type

Artikel-Nr. order code	Bezeichnung description	Länge length
L69C000	ALUMINIUM PROFILE M-LINE REC	2 m
L69C000X	ALUMINIUM PROFILE M-LINE REC	3 m
L69C000Y	ALUMINIUM PROFILE M-LINE REC	5 m
L69C000Z	ALUMINIUM PROFILE M-LINE REC	lfm (max. 5 m)* / per meter (max. 5 m)*
L69C000W	ALUMINIUM PROFILE M-LINE REC weiß / white**	2 m
L69C000WX	ALUMINIUM PROFILE M-LINE REC weiß / white**	3 m
L69C000WZ	ALUMINIUM PROFILE M-LINE REC weiß / white**	lfm (max. 3 m)* / per meter (max. 3 m)*
L69C000B	ALUMINIUM PROFILE M-LINE REC schwarz / black***	2 m
L69C000BX	ALUMINIUM PROFILE M-LINE REC schwarz / black***	3 m
L69C000BZ	ALUMINIUM PROFILE M-LINE REC schwarz / black***	lfm (max. 3 m)* / per meter (max. 3 m)*
L69CS3E	ALUMINIUM END CAP FLAT M-LINE REC	
L69CS3EW	ALUMINIUM END CAP FLAT M-LINE REC weiß / white**	
L69CS3EB	ALUMINIUM END CAP FLAT M-LINE REC schwarz / black***	
L69CR2E	ALUMINIUM END CAP ROUND M-LINE REC	
L69CR2EW	ALUMINIUM END CAP ROUND M-LINE REC weiß / white**	
L69CR2EB	ALUMINIUM END CAP ROUND M-LINE REC schwarz / black***	
L69CS1E	ALUMINIUM END CAP SQUARE M-LINE REC	
L69CS1EW	ALUMINIUM END CAP SQUARE M-LINE REC weiß / white**	
L69CS1EB	ALUMINIUM END CAP SQUARE M-LINE REC schwarz / black***	

* Zuschnitt nach Maß / Custom Length ** weiß RAL 9016 / white RAL 9016 *** schwarz ähnlich RAL 9005 / black similar to RAL 9005



Eine Übersicht welche PROFILE mit welchen STRIPS kompatibel sind, finden Sie auf Seite 250.

For compatibility of PROFILES and STRIPS see page 250.

PLASTIC COVERS M-LINE Seite 216-218 / page 216-218

Formen shapes	Varianten versions
FLAT	CLEAR, FROST, MILKY (OPAL), BLACK
BREAK-PROOF FLAT	CLEAR, FROST, MILKY (OPAL)
OVAL	CLEAR, FROST, MILKY (OPAL)
ROUND	CLEAR, FROST, MILKY (OPAL)
SQUARE	CLEAR, FROST, MILKY (OPAL)

ALUMINIUM PROFILE M-LINE REC 24

PROLED®

1.2

PLASTIC COVERS Seite 216-218 / page 216-218

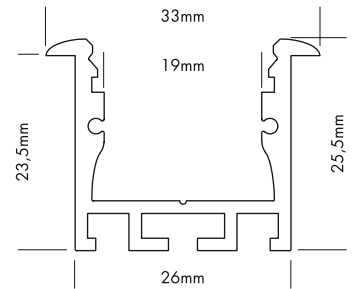

M-LINE REC 24 (zum Wand- oder Deckeneinbau)

M-LINE REC 24 (for wall or ceiling integration)

Vier verschiedene Formen von hochwertigen Kunststoff-abdeckungen stehen zur Verfügung: plan (nicht für DMX STRIP 30 geeignet), oval, halb-rund und eckig

Four different shapes of high quality plastic covers are available: flat (not suitable for the DMX STRIP 30), oval, round and square

Jede der vier Formen ist in glasklar, frost (halbkklar) und milchig frost (opal) erhältlich. Die plane Abdeckung (FLAT) wird auch in schwarz (transluenter Effekt) angeboten.

Each of the four shapes are available in crystal clear, frost (semitransparent) and milky frost (opal). The flat cover (FLAT) is also supplied in black (translucent effect).

Auch ist die plane Abdeckung (FLAT) als begehbare und bruchfeste Variante in glasklar, frost (halbkklar) und milchig frost (opal) erhältlich.

The flat cover (FLAT) is also as a walkable and break-proof version in crystal clear, frost and milky frost (opal) available.

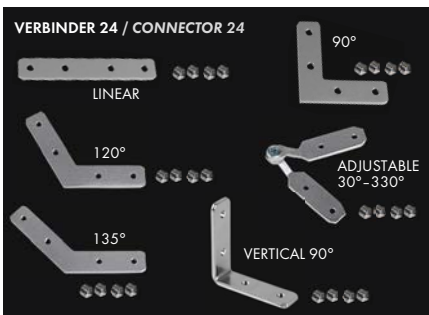
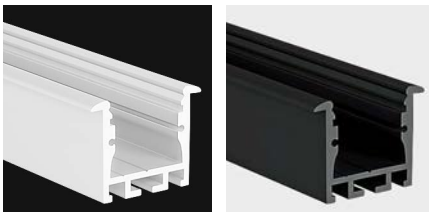

Produkttypen / Product Type

Artikel-Nr. order code	Bezeichnung description	Länge length
L69C024	ALUMINIUM PROFILE M-LINE REC 24	2 m
L69C024X	ALUMINIUM PROFILE M-LINE REC 24	3 m
L69C024Y	ALUMINIUM PROFILE M-LINE REC 24	5 m
L69C024Z	ALUMINIUM PROFILE M-LINE REC 24	l/m (max. 5 m)* / per meter (max. 5 m)*
L69C024W	ALUMINIUM PROFILE M-LINE REC 24 weiß / white**	2 m
L69C024WX	ALUMINIUM PROFILE M-LINE REC 24 weiß / white**	3 m
L69C024WZ	ALUMINIUM PROFILE M-LINE REC 24 weiß / white**	l/m (max. 3 m)* / per meter (max. 3 m)*
L69C024B	ALUMINIUM PROFILE M-LINE REC 24 schwarz / black***	2 m
L69C024BX	ALUMINIUM PROFILE M-LINE REC 24 schwarz / black***	3 m
L69C024BZ	ALUMINIUM PROFILE M-LINE REC 24 schwarz / black***	l/m (max. 3 m)* / per meter (max. 3 m)*
L690007	CONNECTOR 24 LINEAR	
L690008	CONNECTOR 24 90°	
L690010	CONNECTOR 24 120°	
L690011	CONNECTOR 24 135°	
L690012	CONNECTOR 24 VERTICAL 90°	
L690017	CONNECTOR 24 ADJUSTABLE (Winkel einstellbar / angle adjustable)	
L69CS3E	ALUMINIUM END CAP FLAT M-LINE REC	
L69CS3EW	ALUMINIUM END CAP FLAT M-LINE REC weiß / white**	
L69CS3EB	ALUMINIUM END CAP FLAT M-LINE REC schwarz / black***	
L69CR2E	ALUMINIUM END CAP ROUND M-LINE REC	
L69CR2EW	ALUMINIUM END CAP ROUND M-LINE REC weiß / white**	
L69CR2EB	ALUMINIUM END CAP ROUND M-LINE REC schwarz / black***	
L69CS1E	ALUMINIUM END CAP SQUARE M-LINE REC	
L69CS1EW	ALUMINIUM END CAP SQUARE M-LINE REC weiß / white**	
L69CS1EB	ALUMINIUM END CAP SQUARE M-LINE REC schwarz / black***	
L690003	ALUMINIUM PROFILE SPRING MOUNTING CLIP M-LINE / S-LINE Wir empfehlen mindestens 3 Stück pro 2 m. / We suggest minimum 3 pcs per 2 m.	

*Zuschnitt nach Maß / Custom Length ** weiß RAL 9016 / white RAL 9016 *** schwarz ähnlich RAL 9005 / black similar to RAL 9005

Eine Übersicht welche PROFILE mit welchen STRIPS kompatibel sind, finden Sie auf Seite 250.

For compatibility of PROFILES and STRIPS see page 250.

PLASTIC COVERS M-LINE Seite 216-218 / page 216-218

Formen shapes	Varianten versions
FLAT	CLEAR, FROST, MILKY (OPAL), BLACK
BREAK-PROOF FLAT	CLEAR, FROST, MILKY (OPAL)
OVAL	CLEAR, FROST, MILKY (OPAL)
ROUND	CLEAR, FROST, MILKY (OPAL)
SQUARE	CLEAR, FROST, MILKY (OPAL)

ALUMINIUM PROFILE M-LINE REC 24 ST

PROLED®



PLASTIC COVERS Seite 216-218 / page 216-218

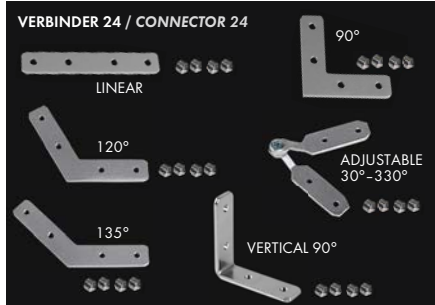

Eine Übersicht welche PROFILE mit welchen STRIPS kompatibel sind, finden Sie auf Seite 250.

For compatibility of PROFILES and STRIPS see page 250.



M-LINE REC 24 ST (zum Wand- oder Deckeneinbau)

Vier verschiedene Formen von hochwertigen Kunststoffabdeckungen stehen zur Verfügung: plan (nicht für DMX STRIP 30 geeignet), oval, halbrund und eckig

Jede der vier Formen ist in glasklar, frost (halbkklar) und milchig frost (opal) erhältlich. Die plane Abdeckung (FLAT) wird auch in schwarz (transluzenter Effekt) angeboten.

Auch ist die plane Abdeckung (FLAT) als begehbare und bruchfeste Variante in glasklar, frost (halbkklar) und milchig frost (opal) erhältlich.

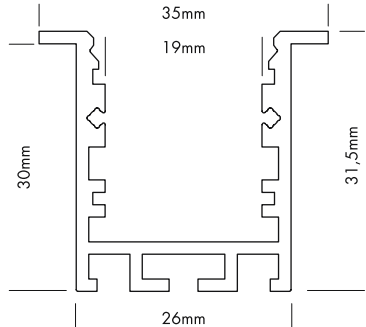

M-LINE REC 24 ST (for wall or ceiling integration)

Four different shapes of high quality plastic covers are available: flat (not suitable for the DMX STRIP 30), oval, round and square

Each of the four shapes are available in crystal clear, frost (semitransparent) and milky frost (opal). The flat cover (FLAT) is also supplied in black (translucent effect).

The flat cover (FLAT) is also as a walkable and break-proof version in crystal clear, frost and milky frost (opal) available.

Produkttypen / Product Type

Artikel-Nr. order code	Bezeichnung description	Länge length
L69C124	ALUMINIUM PROFILE M-LINE REC 24 ST	2 m
L69C124X	ALUMINIUM PROFILE M-LINE REC 24 ST	3 m
L69C124Y	ALUMINIUM PROFILE M-LINE REC 24 ST	5 m
L69C124Z	ALUMINIUM PROFILE M-LINE REC 24 ST	lfm (max. 5 m)* / per meter (max. 5 m)*
L69C124W	ALUMINIUM PROFILE M-LINE REC 24 ST weiß / white**	2 m
L69C124WX	ALUMINIUM PROFILE M-LINE REC 24 ST weiß / white**	3 m
L69C124WZ	ALUMINIUM PROFILE M-LINE REC 24 ST weiß / white**	lfm (max. 3 m)* / per meter (max. 3 m)*
L69C124B	ALUMINIUM PROFILE M-LINE REC 24 ST schwarz / black***	2 m
L69C124BX	ALUMINIUM PROFILE M-LINE REC 24 ST schwarz / black***	3 m
L69C124BZ	ALUMINIUM PROFILE M-LINE REC 24 ST schwarz / black***	lfm (max. 3 m)* / per meter (max. 3 m)*
L690SBS	ALUMINIUM SLIDING BASE M-LINE	2 m
L690SBSZ	ALUMINIUM SLIDING BASE M-LINE	lfm (max. 2 m)* / per meter (max. 2 m)*
L690SBSW	ALUMINIUM SLIDING BASE M-LINE weiß / white**	2 m
L690SBSWZ	ALUMINIUM SLIDING BASE M-LINE weiß / white**	lfm (max. 2 m)* / per meter (max. 2 m)*
L690SBSB	ALUMINIUM SLIDING BASE M-LINE schwarz / black***	2 m
L690SBSBZ	ALUMINIUM SLIDING BASE M-LINE schwarz / black***	lfm (max. 2 m)* / per meter (max. 2 m)*
L690007	CONNECTOR 24 LINEAR	
L690008	CONNECTOR 24 90°	
L690010	CONNECTOR 24 120°	
L690011	CONNECTOR 24 135°	
L690012	CONNECTOR 24 VERTICAL 90°	
L690017	CONNECTOR 24 ADJUSTABLE (Winkel einstellbar / angle adjustable)	
L69C1S3E	ALUMINIUM END CAP FLAT M-LINE REC 24 ST	
L69C1S3EW	ALUMINIUM END CAP FLAT M-LINE REC 24 ST weiß / white**	
L69C1S3EB	ALUMINIUM END CAP FLAT M-LINE REC 24 ST schwarz / black***	
L69C1S3EA	ALUMINIUM END CAP FLAT ARM M-LINE REC 24 ST	
L69C1S3EAW	ALUMINIUM END CAP FLAT ARM M-LINE REC 24 ST weiß / white**	
L69C1S3EAB	ALUMINIUM END CAP FLAT ARM M-LINE REC 24 ST schwarz / black***	
L690003	ALUMINIUM PROFILE SPRING MOUNTING CLIP M-LINE / S-LINE Wir empfehlen mindestens 3 Stück pro 2 m. / We suggest minimum 3 pcs per 2 m.	

*Zuschnitt nach Maß / Custom Length **weiß RAL 9016 / white RAL 9016 ***schwarz ähnlich RAL 9005 / black similar to RAL 9005

PLASTIC COVERS M-LINE Seite 216-218 / page 216-218

Formen shapes	Varianten versions
FLAT	CLEAR, FROST, MILKY (OPAL), BLACK
BREAK-PROOF FLAT	CLEAR, FROST, MILKY (OPAL)
OVAL	CLEAR, FROST, MILKY (OPAL)
ROUND	CLEAR, FROST, MILKY (OPAL)
SQUARE	CLEAR, FROST, MILKY (OPAL)

ALUMINIUM PROFILE M-LINE GRID

PROLED®

1.2



PLASTIC COVERS Seite 216-218 / page 216-218

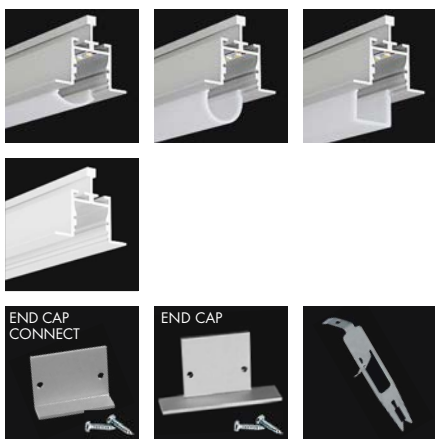
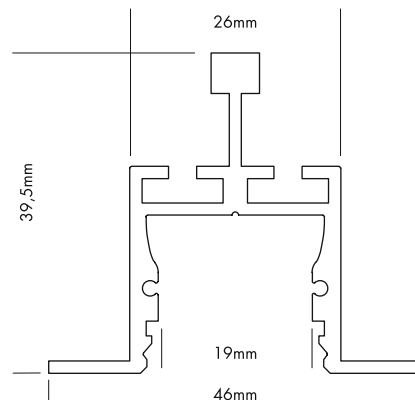

M-LINE GRID

Vier verschiedene Formen von hochwertigen Kunststoff-abdeckungen stehen zur Verfügung: plan (nicht für DMX STRIP 30 geeignet), oval, halb-rund und eckig

Jede der vier Formen ist in glasklar, frost (halbkklar) und milchig frost (opal) erhältlich. Die plane Abdeckung (FLAT) wird auch in schwarz (transluenter Effekt) angeboten.

Auch ist die plane Abdeckung (FLAT) als begehbare und bruchfeste Variante in glasklar, frost (halbkklar) und milchig frost (opal) erhältlich.

M-LINE GRID

Four different shapes of high quality plastic covers are available: flat (not suitable for the DMX STRIP 30), oval, round and square

Each of the four shapes are available in crystal clear, frost (semitransparent) and milky frost (opal). The flat cover (FLAT) is also supplied in black (translucent effect).

The flat cover (FLAT) is also as a walkable and break-proof version in crystal clear, frost and milky frost (opal) available.

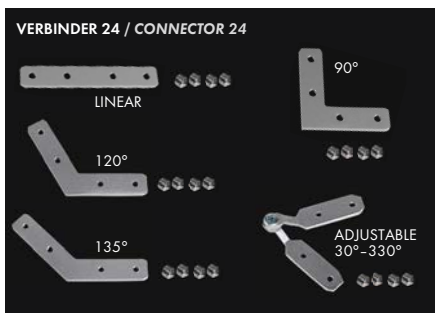

Produkttypen / Product Type

Artikel-Nr. order code	Bezeichnung description	Länge length
L69M000	ALUMINIUM PROFILE M-LINE GRID	2 m
L69M000X	ALUMINIUM PROFILE M-LINE GRID	3 m
L69M000Y	ALUMINIUM PROFILE M-LINE GRID	5 m
L69M000Z	ALUMINIUM PROFILE M-LINE GRID	lfm (max. 5 m)* / per meter (max. 5 m)*
L69M000W	ALUMINIUM PROFILE M-LINE GRID weiß / white**	2 m
L69M000WZ	ALUMINIUM PROFILE M-LINE GRID weiß / white**	lfm (max. 2 m)* / per meter (max. 2 m)*
L690007	CONNECTOR 24 LINEAR	
L690008	CONNECTOR 24 90°	
L690010	CONNECTOR 24 120°	
L690011	CONNECTOR 24 135°	
L690017	CONNECTOR 24 ADJUSTABLE (Winkel einstellbar / angle adjustable)	
L69MS3E	ALUMINIUM END CAP FLAT M-LINE GRID CONNECT	
L69MS3E1	ALUMINIUM END CAP FLAT M-LINE GRID	
L69MS3E1W	ALUMINIUM END CAP FLAT M-LINE GRID weiß / white**	
L690009	SPANNABHÄNGER NR. 12/44 / CLAMP HANGER NO. 12/44	

*Zuschnitt nach Maß / Custom Length

**weiß RAL 9016 / white RAL 9016

Eine Übersicht welche PROFILE mit welchen STRIPS kompatibel sind, finden Sie auf Seite 250.

For compatibility of PROFILES and STRIPS see page 250.

PLASTIC COVERS M-LINE Seite 216-218 / page 216-218

Formen shapes	Varianten versions
FLAT	CLEAR, FROST, MILKY (OPAL), BLACK
BREAK-PROOF FLAT	CLEAR, FROST, MILKY (OPAL)
OVAL	CLEAR, FROST, MILKY (OPAL)
ROUND	CLEAR, FROST, MILKY (OPAL)
SQUARE	CLEAR, FROST, MILKY (OPAL)

ALUMINIUM PROFILE M-LINE CORNER

PROLED®



PLASTIC COVERS Seite 216-218 / page 216-218

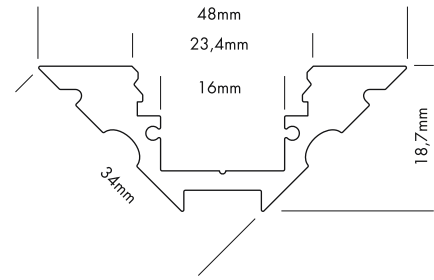

M-LINE CORNER (für Eckmontage)

Vier verschiedene Formen von hochwertigen Kunststoffabdeckungen stehen zur Verfügung: plan, oval, halbrund und eckig

Jede der vier Formen ist in glasklar, frost (halbkklar) und milchig frost (opal) erhältlich. Die plane Abdeckung (FLAT) wird auch in schwarz (transluzenter Effekt) angeboten.

Auch ist die plane Abdeckung (FLAT) als begehbare und bruchfeste Variante in glasklar, frost (halbkklar) und milchig frost (opal) erhältlich.

Mit dem LENS COVER 45° wird eine Bündelung und somit ein engerer Abstrahlwinkel erzeugt. Je nach Abstand zwischen FLEX STRIP und LENS COVER ist der Abstrahlwinkel max. 45°.

M-LINE CORNER (for mounting in a corner)

Four different shapes of high quality plastic covers are available: flat, oval, round and square

Each of the four shapes are available in crystal clear, frost (semitransparent) and milky frost (opal). The flat cover (FLAT) is also supplied in black (translucent effect).

The flat cover (FLAT) is also as a walkable and break-proof version in crystal clear, frost and milky frost (opal) available.

The LENS COVER 45° provides a concentration of light rays and therefore a narrower beam angle. Depending on the distance between FLEX STRIP and LENS COVER the max. beam angle is 45°.

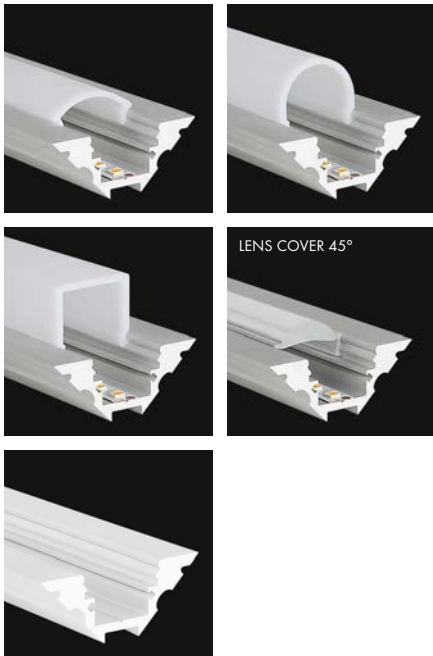

LENS COVER 45°



Produkttypen / Product Type

Artikel-Nr. order code	Bezeichnung description	Länge length
L69D000	ALUMINIUM PROFILE M-LINE CORNER	2 m
L69D000X	ALUMINIUM PROFILE M-LINE CORNER	3 m
L69D000Y	ALUMINIUM PROFILE M-LINE CORNER	5 m
L69D000Z	ALUMINIUM PROFILE M-LINE CORNER	1fm (max. 5 m)* / per meter (max. 5 m)*
L69D000W	ALUMINIUM PROFILE M-LINE CORNER weiß / white**	2 m
L69D000WX	ALUMINIUM PROFILE M-LINE CORNER weiß / white**	3 m
L69D000WZ	ALUMINIUM PROFILE M-LINE CORNER weiß / white**	1fm (max. 3 m)* / per meter (max. 3 m)*
L69DS3E	ALUMINIUM END CAP FLAT M-LINE CORNER	
L69DS3EW	ALUMINIUM END CAP FLAT M-LINE CORNER weiß / white**	
L69DR2E	ALUMINIUM END CAP ROUND M-LINE CORNER	
L69DR2EW	ALUMINIUM END CAP ROUND M-LINE CORNER weiß / white**	
L69DS1E	ALUMINIUM END CAP SQUARE M-LINE CORNER	
L69DS1EW	ALUMINIUM END CAP SQUARE M-LINE CORNER weiß / white**	

* Zuschnitt nach Maß / Custom Length

** weiß RAL 9016 / white RAL 9016

Eine Übersicht welche PROFILE mit welchen STRIPS kompatibel sind, finden Sie auf Seite 250.

For compatibility of PROFILES and STRIPS see page 250.

PLASTIC COVERS M-LINE Seite 216-218 / page 216-218

Formen shapes	Varianten versions
FLAT	CLEAR, FROST, MILKY (OPAL), BLACK
BREAK-PROOF FLAT	CLEAR, FROST, MILKY (OPAL)
OVAL	CLEAR, FROST, MILKY (OPAL)
ROUND	CLEAR, FROST, MILKY (OPAL)
SQUARE	CLEAR, FROST, MILKY (OPAL)
LENS 45°	CLEAR

ALUMINIUM PROFILE M-LINE DRYWALL LINEAR

PROLED®

1.2

PLASTIC COVERS Seite 216-218 / page 216-218

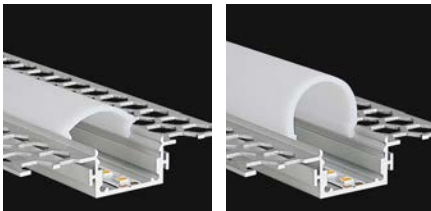
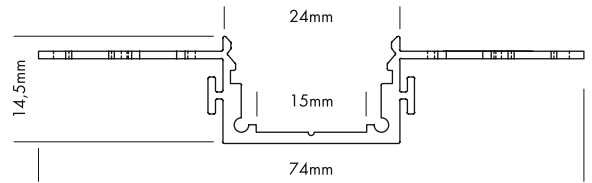

Die ALUMINIUM PROFILE M-LINE DRYWALL sind für den nahtlosen Einbau als Vouten-, Wand- oder Deckenbeleuchtung beim Trockenbau (Gipskarton) geeignet.

The ALUMINIUM PROFILES M-LINE DRYWALL are suitable for a seamless installation as wall or ceiling lighting in drywall installations.

- horizontale und vertikale Einsatzmöglichkeit
- nahtlose Integration möglich

- horizontal or vertical installation
- seamless integration possible

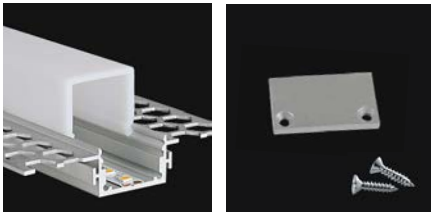

Vier verschiedene Formen von hochwertigen Kunststoffabdeckungen stehen zur Verfügung: plan, oval, halbrund und eckig

Four different shapes of high quality plastic covers are available: flat, oval, round and square

Jede der vier Formen ist in glasklar, frost (halbkklar) und milchig frost (opal) erhältlich. Die plane Abdeckung (FLAT) wird auch in schwarz (transluenter Effekt) angeboten.

Each of the four shapes are available in crystal clear, frost (semitransparent) and milky frost (opal). The flat cover (FLAT) is also supplied in black (translucent effect).



Auch ist die plane Abdeckung (FLAT) als begehbare und bruchfeste Variante in glasklar, frost (halbkklar) und milchig frost (opal) erhältlich.

The flat cover (FLAT) is also as a walkable and break-proof version in crystal clear, frost and milky frost (opal) available.

Produkttypen / Product Type

Artikel-Nr. order code	Bezeichnung description	Länge length
L6900DL	ALUMINIUM PROFILE M-LINE DRYWALL LINEAR	2 m
L6900DLZ	ALUMINIUM PROFILE M-LINE DRYWALL LINEAR	lfm (max. 2 m)* / per meter (max. 2 m)*
L6900DE	ALUMINIUM END CAP FLAT M-LINE DRYWALL	
L6B0001	Anstrichvlies 60 mm breit, 20 m / fleece 60 mm wide, 20 m	
L6B0002	Anstrichvlies 90 mm breit, 20 m / fleece 90 mm wide, 20 m	

*Zuschnitt nach Maß / Custom Length

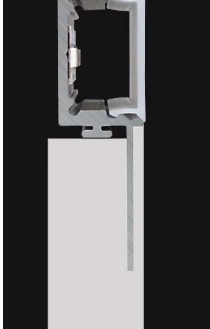

Eine Übersicht welche PROFILE mit welchen STRIPS kompatibel sind, finden Sie auf Seite 250.

For compatibility of PROFILES and STRIPS see page 250.

PLASTIC COVERS M-LINE Seite 216-218 / page 216-218

Formen shapes	Varianten versions
FLAT	CLEAR, FROST, MILKY (OPAL), BLACK
BREAK-PROOF FLAT	CLEAR, FROST, MILKY (OPAL)
OVAL	CLEAR, FROST, MILKY (OPAL)
ROUND	CLEAR, FROST, MILKY (OPAL)
SQUARE	CLEAR, FROST, MILKY (OPAL)

ALUMINIUM PROFILE M-LINE DRYWALL CORNER INTERNAL

PROLED®

PLASTIC COVERS Seite 216-218 / page 216-218

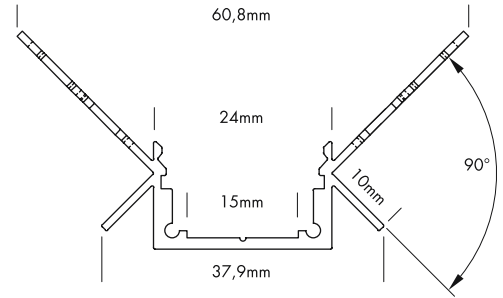
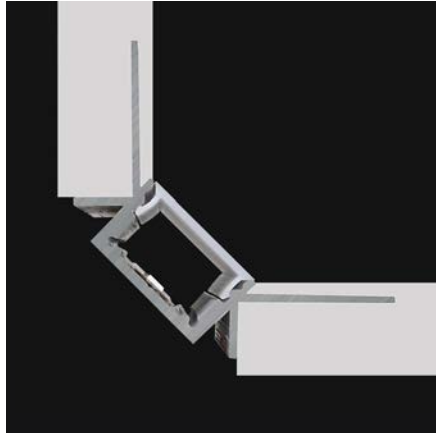
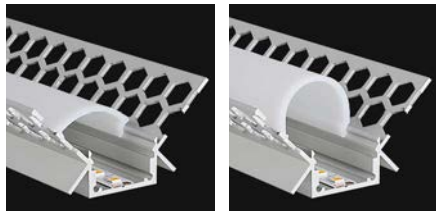

5 Years
★ ★ ★ ★ ★
SEE PAGE 4

Die ALUMINIUM PROFILE M-LINE DRYWALL sind für den nahtlosen Einbau als Vouten-, Wand- oder Deckenbeleuchtung beim Trockenbau (Gipskarton) geeignet.

- horizontale und vertikale Einsatzmöglichkeit
- nahtlose Integration möglich

Vier verschiedene Formen von hochwertigen Kunststoffabdeckungen stehen zur Verfügung: plan, oval, halbrund und eckig

Jede der vier Formen ist in glasklar, frost (halbkklar) und milchig frost (opal) erhältlich. Die plane Abdeckung (FLAT) wird auch in schwarz (transluzenter Effekt) angeboten.

Auch ist die plane Abdeckung (FLAT) als begehbare und bruchfeste Variante in glasklar, frost (halbkklar) und milchig frost (opal) erhältlich.

The ALUMINIUM PROFILES M-LINE DRYWALL are suitable for a seamless installation as wall or ceiling lighting in drywall installations.

- horizontal or vertical installation
- seamless integration possible

Four different shapes of high quality plastic covers are available: flat, oval, round and square

Each of the four shapes are available in crystal clear, frost (semitransparent) and milky frost (opal). The flat cover (FLAT) is also supplied in black (translucent effect).

The flat cover (FLAT) is also as a walkable and break-proof version in crystal clear, frost and milky frost (opal) available.

Produkttypen / Product Type

Artikel-Nr. order code	Bezeichnung description	Länge length
L6900DCI	ALUMINIUM PROFILE M-LINE DRYWALL CORNER INTERNAL	2 m
L6900DCIZ	ALUMINIUM PROFILE M-LINE DRYWALL CORNER INTERNAL	lfm (max. 2 m)* / per meter (max. 2 m)*
L6900DE	ALUMINIUM END CAP FLAT M-LINE DRYWALL	
L6B0001	Anstrichvlies 60 mm breit, 20 m / fleece 60 mm wide, 20 m	
L6B0002	Anstrichvlies 90 mm breit, 20 m / fleece 90 mm wide, 20 m	

*Zuschnitt nach Maß / Custom Length

PLASTIC COVERS M-LINE Seite 216-218 / page 216-218

Formen shapes	Varianten versions
FLAT	CLEAR, FROST, MILKY [OPAL], BLACK
BREAK-PROOF FLAT	CLEAR, FROST, MILKY [OPAL]
OVAL	CLEAR, FROST, MILKY [OPAL]
ROUND	CLEAR, FROST, MILKY [OPAL]
SQUARE	CLEAR, FROST, MILKY [OPAL]

Eine Übersicht welche PROFILE mit welchen STRIPS kompatibel sind, finden Sie auf Seite 250.

For compatibility of PROFILES and STRIPS see page 250.

ALUMINIUM PROFILE M-LINE DRYWALL CORNER EXTERNAL

PROLED®

1.2

PLASTIC COVERS Seite 216-218 / page 216-218

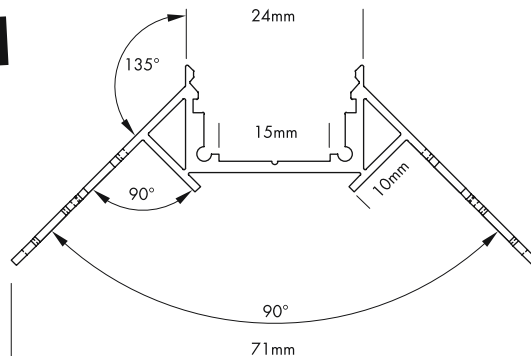

5 Years

SEE PAGE 4



Die ALUMINIUM PROFILE M-LINE DRYWALL sind für den nahtlosen Einbau als Vouten-, Wand- oder Deckenbeleuchtung beim Trockenbau (Gipskarton) geeignet.

The ALUMINIUM PROFILES M-LINE DRYWALL are suitable for a seamless installation as wall or ceiling lighting in drywall installations.

- horizontale und vertikale Einsatzmöglichkeit
- nahtlose Integration möglich

- horizontal or vertical installation
- seamless integration possible

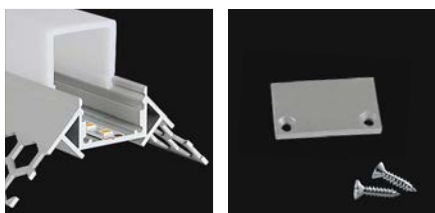

Vier verschiedene Formen von hochwertigen Kunststoffabdeckungen stehen zur Verfügung: plan, oval, halbrund und eckig

Four different shapes of high quality plastic covers are available: flat, oval, round and square

Jede der vier Formen ist in glasklar, frost (halbkklar) und milchig frost (opal) erhältlich. Die plane Abdeckung (FLAT) wird auch in schwarz (transluzenter Effekt) angeboten.

Each of the four shapes are available in crystal clear, frost (semitransparent) and milky frost (opal). The flat cover (FLAT) is also supplied in black (translucent effect).



Auch ist die plane Abdeckung (FLAT) als begehbare und bruchfeste Variante in glasklar, frost (halbkklar) und milchig frost (opal) erhältlich.

The flat cover (FLAT) is also as a walkable and break-proof version in crystal clear, frost and milky frost (opal) available.

Produkttypen / Product Type

Artikel-Nr. order code	Bezeichnung description	Länge length
L6900DCE	ALUMINIUM PROFILE M-LINE DRYWALL CORNER EXTERNAL	2 m
L6900DCEZ	ALUMINIUM PROFILE M-LINE DRYWALL CORNER EXTERNAL	l _{fm} (max. 2 m)* / per meter (max. 2 m)*
L6900DE	ALUMINIUM END CAP FLAT M-LINE DRYWALL	
L6B0001	Anstrichvlies 60 mm breit, 20 m / fleece 60 mm wide, 20 m	
L6B0002	Anstrichvlies 90 mm breit, 20 m / fleece 90 mm wide, 20 m	

*Zuschnitt nach Maß / Custom Length



PLASTIC COVERS M-LINE Seite 216-218 / page 216-218

Formen shapes	Varianten versions
FLAT	CLEAR, FROST, MILKY (OPAL), BLACK
BREAK-PROOF FLAT	CLEAR, FROST, MILKY (OPAL)
OVAL	CLEAR, FROST, MILKY (OPAL)
ROUND	CLEAR, FROST, MILKY (OPAL)
SQUARE	CLEAR, FROST, MILKY (OPAL)

Eine Übersicht welche PROFILE mit welchen STRIPS kompatibel sind, finden Sie auf Seite 250.

For compatibility of PROFILES and STRIPS see page 250.



ALUMINIUM PROFILE M-LINE H



PLASTIC COVERS Seite 216-218 / page 216-218



M-LINE H

Vier verschiedene Formen von hochwertigen Kunststoffabdeckungen stehen zur Verfügung: plan (nicht für DMX STRIP 30 geeignet), oval, halbrund und eckig

Jede der vier Formen ist in glasklar, frost (halbkklar) und milchig frost (opal) erhältlich. Die plane Abdeckung (FLAT) wird auch in schwarz (transluenter Effekt) angeboten.

Auch ist die plane Abdeckung (FLAT) als begehbare und bruchfeste Variante in glasklar, frost (halbkklar) und milchig frost (opal) erhältlich.

Mit dem LENS COVER 45° wird eine Bündelung und somit ein engerer Abstrahlwinkel erzeugt. Je nach Abstand zwischen FLEX STRIP und LENS COVER ist der Abstrahlwinkel max. 45°. Das LENS COVER 45° ist nicht für den DMX STRIP 30 geeignet.

M-LINE H

Four different shapes of high quality plastic covers are available: flat (not suitable for the DMX STRIP 30), oval, round and square

Each of the four shapes are available in crystal clear, frost (semitransparent) and milky frost (opal). The flat cover (FLAT) is also supplied in black (translucent effect).

The flat cover (FLAT) is also as a walkable and break-proof version in crystal clear, frost and milky frost (opal) available.

The LENS COVER 45° provides a concentration of light rays and therefore a narrower beam angle. Depending on the distance between FLEX STRIP and LENS COVER the max. beam angle is 45°. The LENS COVER 45° is not suitable for the DMX STRIP 30.

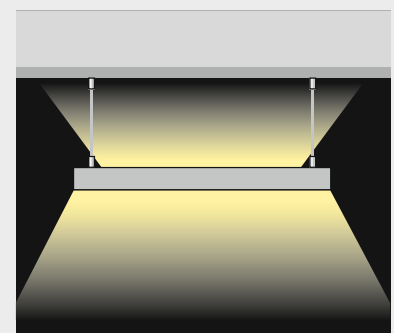
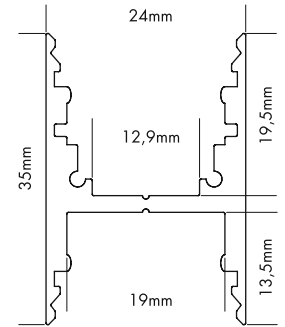

Bei Abhängung von der Decke auch beidseitige Bestückung mit FLEX STRIPS möglich (Abstrahlung nach oben und unten).

When suspended from the ceiling a double-sided installation with FLEX STRIPS is also possible (emission up- and downwards).

Kunststoffabdeckung bruchfest / Plastic cover break-proof

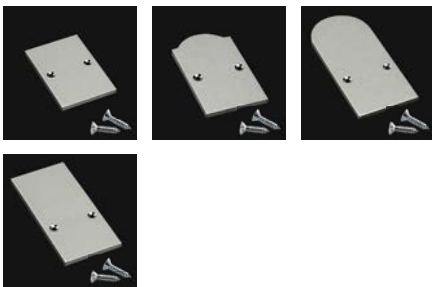
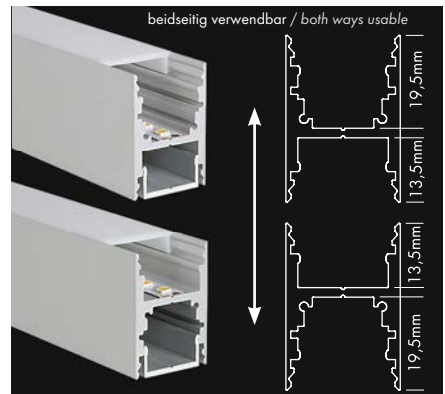

Produkttypen / Product Type

Artikel-Nr. order code	Bezeichnung description	Länge length
L69H000	ALUMINIUM PROFILE M-LINE H	2 m
L69H000X	ALUMINIUM PROFILE M-LINE H	3 m
L69H000Y	ALUMINIUM PROFILE M-LINE H	5 m
L69H000Z	ALUMINIUM PROFILE M-LINE H	lfm (max. 5 m)* / per meter (max. 5 m)*
L69H000W	ALUMINIUM PROFILE M-LINE H weiß / white**	2 m
L69H000WX	ALUMINIUM PROFILE M-LINE H weiß / white**	3 m
L69H000WZ	ALUMINIUM PROFILE M-LINE H weiß / white**	lfm (max. 3 m)* / per meter (max. 3 m)*
L69H000B	ALUMINIUM PROFILE M-LINE H schwarz / black***	2 m
L69H000BX	ALUMINIUM PROFILE M-LINE H schwarz / black***	3 m
L69H000BZ	ALUMINIUM PROFILE M-LINE H schwarz / black***	lfm (max. 3 m)* / per meter (max. 3 m)*
L690004	ALUMINIUM MOUNTING PROFILE	2 m
L690004Z	ALUMINIUM MOUNTING PROFILE	lfm (max. 2 m)* / per meter (max. 2 m)*
L690SBS	ALUMINIUM SLIDING BASE M-LINE	2 m
L690SBSZ	ALUMINIUM SLIDING BASE M-LINE	lfm (max. 2 m)* / per meter (max. 2 m)*
L690SBSW	ALUMINIUM SLIDING BASE M-LINE weiß / white**	2 m
L690SBSWZ	ALUMINIUM SLIDING BASE M-LINE weiß / white**	lfm (max. 2 m)* / per meter (max. 2 m)*
L690SBSB	ALUMINIUM SLIDING BASE M-LINE schwarz / black***	2 m
L690SBSBZ	ALUMINIUM SLIDING BASE M-LINE schwarz / black***	lfm (max. 2 m)* / per meter (max. 2 m)*
L69HS3E	ALUMINIUM END CAP FLAT M-LINE H	
L69HS3EW	ALUMINIUM END CAP FLAT M-LINE H weiß / white**	
L69HS3EB	ALUMINIUM END CAP FLAT M-LINE H schwarz / black***	
L69HR2E	ALUMINIUM END CAP ROUND M-LINE H	
L69HR2EW	ALUMINIUM END CAP ROUND M-LINE H weiß / white**	
L69HR2EB	ALUMINIUM END CAP ROUND M-LINE H schwarz / black***	
L69HS1E	ALUMINIUM END CAP SQUARE M-LINE H	
L69HS1EW	ALUMINIUM END CAP SQUARE M-LINE H weiß / white**	
L69HS1EB	ALUMINIUM END CAP SQUARE M-LINE H schwarz / black***	
L69HL45E	ALUMINIUM END CAP LENS 45° M-LINE H	
L69HL45EW	ALUMINIUM END CAP LENS 45° M-LINE H weiß / white**	
L69HL45EB	ALUMINIUM END CAP LENS 45° M-LINE H schwarz / black***	

*Zuschnitt nach Maß / Custom Length **weiß RAL 9016 / white RAL 9016 ***schwarz ähnlich RAL 9005 / black similar to RAL 9005

Eine Übersicht welche PROFILE mit welchen STRIPS kompatibel sind, finden Sie auf Seite 250.

For compatibility of PROFILES and STRIPS see page 250.

PLASTIC COVERS M-LINE Seite 216-218 / page 216-218

Formen shapes	Varianten versions
FLAT	CLEAR, FROST, MILKY (OPAL), BLACK
BREAK-PROOF FLAT	CLEAR, FROST, MILKY (OPAL)
OVAL	CLEAR, FROST, MILKY (OPAL)
ROUND	CLEAR, FROST, MILKY (OPAL)
SQUARE	CLEAR, FROST, MILKY (OPAL)
LENS 45°	CLEAR

ALUMINIUM PROFILE M-LINE 2W

PROLED®

1.2

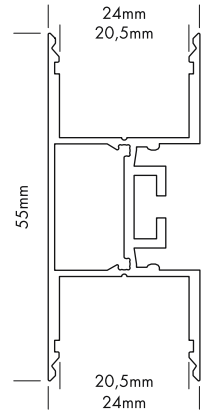
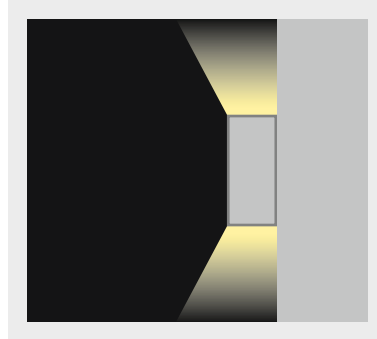

5 Years
★★★★
SEE PAGE 4



M-LINE 2W

Eine plane Kunststoffabdeckung steht in vier Varianten zur Verfügung:

- glasklar
- frost (halbklar)
- milchig frost (opal)
- schwarz (transluzenter Effekt)

M-LINE 2W

Flat plastic covers are available in following versions:

- crystal clear
- frost (semitransparent)
- milky frost (opal)
- black (translucent effect)



Produkttypen / Product Type

Artikel-Nr. order code	Bezeichnung description	Länge length
L69W002	ALUMINIUM PROFILE M-LINE 2W	2 m
L69W002X	ALUMINIUM PROFILE M-LINE 2W	3 m
L69W002Z	ALUMINIUM PROFILE M-LINE 2W	lfm (max. 3 m)* / per meter (max. 3 m)*
L69W002W	ALUMINIUM PROFILE M-LINE 2W weiß / white**	2 m
L69W002WX	ALUMINIUM PROFILE M-LINE 2W weiß / white**	3 m
L69W002WZ	ALUMINIUM PROFILE M-LINE 2W weiß / white**	lfm (max. 3 m)* / per meter (max. 3 m)*
L69W002B	ALUMINIUM PROFILE M-LINE 2W schwarz / black***	2 m
L69W002BX	ALUMINIUM PROFILE M-LINE 2W schwarz / black***	3 m
L69W002BZ	ALUMINIUM PROFILE M-LINE 2W schwarz / black***	lfm (max. 3 m)* / per meter (max. 3 m)*
L690004	ALUMINIUM MOUNTING PROFILE	2 m
L690004Z	ALUMINIUM MOUNTING PROFILE	lfm (max. 2 m)* / per meter (max. 2 m)*
L690007	CONNECTOR 24 LINEAR	
L690008	CONNECTOR 24 90°	
L690010	CONNECTOR 24 120°	
L690011	CONNECTOR 24 135°	
L690012	CONNECTOR 24 VERTICAL 90°	
L69WS2E	ALUMINIUM END CAP FLAT M-LINE 2W	
L69WS2EW	ALUMINIUM END CAP FLAT M-LINE 2W weiß / white**	
L69WS2EB	ALUMINIUM END CAP FLAT M-LINE 2W schwarz / black***	
L690003	ALUMINIUM PROFILE SPRING MOUNTING CLIP M-LINE / S-LINE <small>Wir empfehlen mindestens 4 Stück pro 2 m. / We suggest minimum 4 pcs per 2 m.</small>	

*Zuschnitt nach Maß / Custom Length **weiß RAL 9016 / white RAL 9016 ***schwarz ähnlich RAL 9005 / black similar to RAL 9005

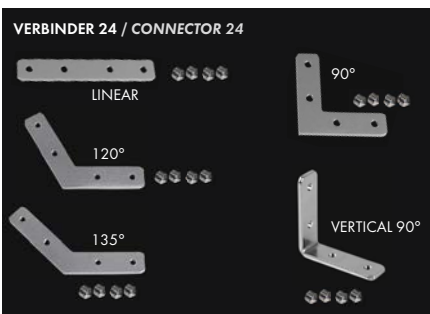

Eine Übersicht welche PROFILE mit welchen STRIPS kompatibel sind, finden Sie auf Seite 250.

For compatibility of PROFILES and STRIPS see page 250.

PLASTIC COVERS M-LINE Seite 216-218 / page 216-218

Formen shapes	Varianten versions
FLAT	CLEAR, FROST, MILKY (OPAL), BLACK
BREAK-PROOF FLAT	CLEAR, FROST, MILKY (OPAL)



ALUMINIUM PROFILE M-LINE 3W

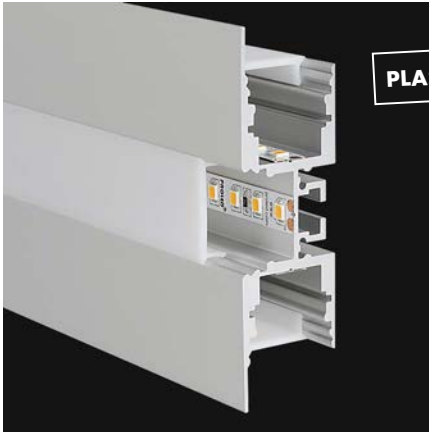

PLASTIC COVERS Seite 216-218 / page 216-218

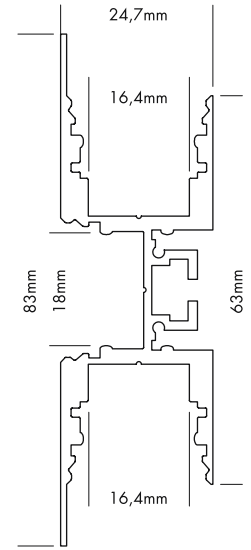
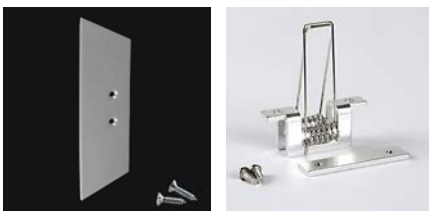
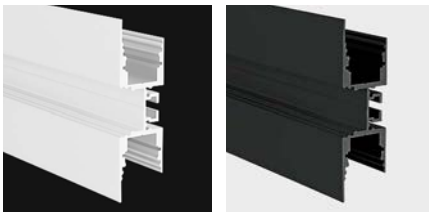

M-LINE 3W

Vier verschiedene Formen von hochwertigen Kunststoff-abdeckungen stehen zur Verfügung: plan (nicht für DMX STRIP 30 geeignet), oval, halbrund und eckig

Jede der vier Formen ist in glasklar, frost (halbkklar) und milchig frost (opal) erhältlich. Die plane Abdeckung (FLAT) wird auch in schwarz (transluzenter Effekt) angeboten.

Auch ist die plane Abdeckung (FLAT) als begehbare und bruchfeste Variante in glasklar, frost (halbkklar) und milchig frost (opal) erhältlich.

M-LINE 3W

Four different shapes of high quality plastic covers are available: flat (not suitable for the DMX STRIP 30), oval, round and square

Each of the four shapes are available in crystal clear, frost (semitransparent) and milky frost (opal). The flat cover (FLAT) is also supplied in black (translucent effect).

The flat cover (FLAT) is also as a walkable and break-proof version in crystal clear, frost and milky frost (opal) available.

PLASTIC COVERS M-LINE Seite 216-218 / page 216-218

Formen shapes	Varianten versions
FLAT	CLEAR, FROST, MILKY (OPAL), BLACK
BREAK-PROOF FLAT	CLEAR, FROST, MILKY (OPAL)
OVAL	CLEAR, FROST, MILKY (OPAL)
ROUND	CLEAR, FROST, MILKY (OPAL)
SQUARE	CLEAR, FROST, MILKY (OPAL)

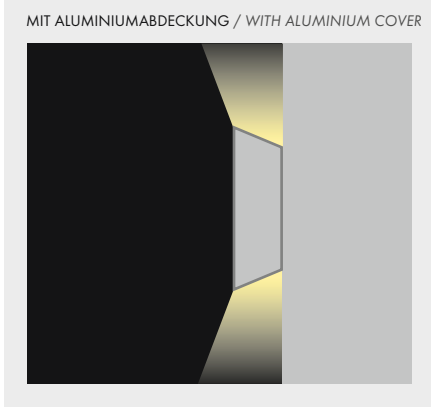
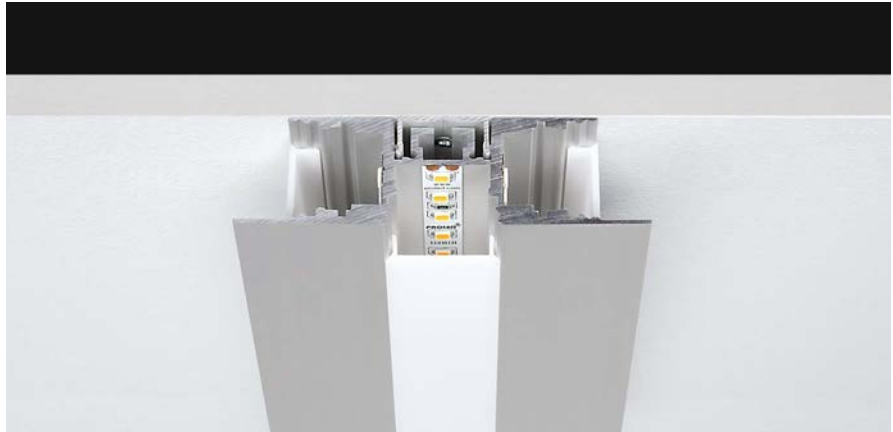

Produkttypen / Product Type

Artikel-Nr. order code	Bezeichnung description	Länge length
L69W000	ALUMINIUM PROFILE M-LINE 3W	2 m
L69W000X	ALUMINIUM PROFILE M-LINE 3W	3 m
L69W000Y	ALUMINIUM PROFILE M-LINE 3W	5 m
L69W000Z	ALUMINIUM PROFILE M-LINE 3W	lfm (max. 5 m)* / per meter (max. 5 m)*
L69W000W	ALUMINIUM PROFILE M-LINE 3W weiß / white**	2 m
L69W000WX	ALUMINIUM PROFILE M-LINE 3W weiß / white**	3 m
L69W000WZ	ALUMINIUM PROFILE M-LINE 3W weiß / white**	lfm (max. 3 m)* / per meter (max. 3 m)*
L69W000B	ALUMINIUM PROFILE M-LINE 3W schwarz / black***	2 m
L69W000BX	ALUMINIUM PROFILE M-LINE 3W schwarz / black***	3 m
L69W000BZ	ALUMINIUM PROFILE M-LINE 3W schwarz / black***	lfm (max. 3 m)* / per meter (max. 3 m)*
L690S3A2	ALUMINIUM COVER M-LINE	2 m
L690S3A2W	ALUMINIUM COVER M-LINE weiß / white**	2 m
L690S3A2B	ALUMINIUM COVER M-LINE schwarz / black***	2 m
L690004	ALUMINIUM MOUNTING PROFILE	2 m
L690004Z	ALUMINIUM MOUNTING PROFILE	lfm (max. 2 m)* / per meter (max. 2 m)*
L690SBS	ALUMINIUM SLIDING BASE M-LINE	2 m
L690SBSZ	ALUMINIUM SLIDING BASE M-LINE	lfm (max. 2 m)* / per meter (max. 2 m)*
L690SBSW	ALUMINIUM SLIDING BASE M-LINE weiß / white**	2 m
L690SBSWZ	ALUMINIUM SLIDING BASE M-LINE weiß / white**	lfm (max. 2 m)* / per meter (max. 2 m)*
L690SBSB	ALUMINIUM SLIDING BASE M-LINE schwarz / black***	2 m
L690SBSBZ	ALUMINIUM SLIDING BASE M-LINE schwarz / black***	lfm (max. 2 m)* / per meter (max. 2 m)*
L69WS3E	ALUMINIUM END CAP FLAT M-LINE 3W	
L69WS3EW	ALUMINIUM END CAP FLAT M-LINE 3W weiß / white**	
L69WS3EB	ALUMINIUM END CAP FLAT M-LINE 3W schwarz / black***	
L690003	ALUMINIUM PROFILE SPRING MOUNTING CLIP M-LINE / S-LINE Wir empfehlen mindestens 4 Stück pro 2 m. / We suggest minimum 4 pcs per 2 m.	

Eine Übersicht welche PROFILE mit welchen STRIPS kompatibel sind, finden Sie auf Seite 250.

For compatibility of PROFILES and STRIPS see page 250.

*Zuschnitt nach Maß / Custom Length **weiß RAL 9016 / white RAL 9016 ***schwarz ähnlich RAL 9005 / black similar to RAL 9005

ALUMINIUM PROFILE M-LINE CIRCLE

1.2

PLASTIC COVERS Seite 216-218 / page 216-218

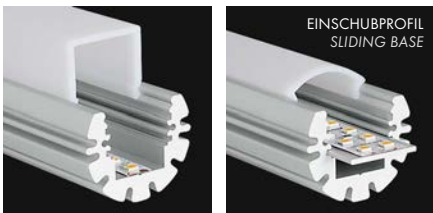
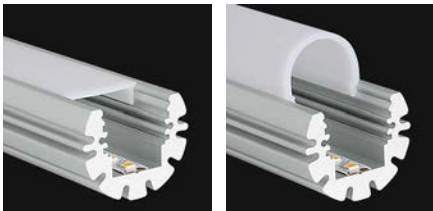

EINSCHUBPROFIL / SLIDING BASE

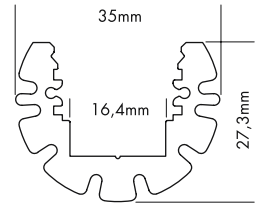
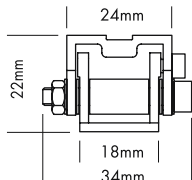
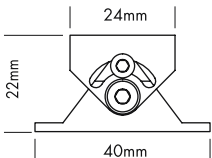
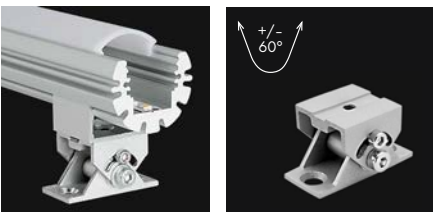

M-LINE CIRCLE

Vier verschiedene Formen von hochwertigen Kunststoff-abdeckungen stehen zur Verfügung: plan (nicht für DMX STRIP 30 geeignet), oval, halb-rund und eckig

Jede der vier Formen ist in glasklar, frost (halbkklar) und milchig frost (opal) erhältlich. Die plane Abdeckung (FLAT) wird auch in schwarz (transluenter Effekt) angeboten.

Auch ist die plane Abdeckung (FLAT) als begehbare und bruchfeste Variante in glasklar, frost (halbkklar) und milchig frost (opal) erhältlich.

M-LINE CIRCLE

Four different shapes of high quality plastic covers are available: flat (not suitable for the DMX STRIP 30), oval, round and square

Each of the four shapes are available in crystal clear, frost (semitransparent) and milky frost (opal). The flat cover (FLAT) is also supplied in black (translucent effect).

The flat cover (FLAT) is also as a walkable and break-proof version in crystal clear, frost and milky frost (opal) available.

EINSCHUBPROFIL / SLIDING BASE

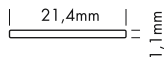

Produkttypen / Product Type

Artikel-Nr. order code	Bezeichnung description	Länge length
L69G000	ALUMINIUM PROFILE M-LINE CIRCLE	2 m
L69G000X	ALUMINIUM PROFILE M-LINE CIRCLE	3 m
L69G000Z	ALUMINIUM PROFILE M-LINE CIRCLE	l _{fm} (max. 3 m)* / per meter (max. 3 m)*
L69G000W	ALUMINIUM PROFILE M-LINE CIRCLE weiß / white**	2 m
L69G000WX	ALUMINIUM PROFILE M-LINE CIRCLE weiß / white**	3 m
L69G000WZ	ALUMINIUM PROFILE M-LINE CIRCLE weiß / white**	l _{fm} (max. 3 m)* / per meter (max. 3 m)*
L690SBS	ALUMINIUM SLIDING BASE M-LINE	2 m
L690SBSZ	ALUMINIUM SLIDING BASE M-LINE	l _{fm} (max. 2 m)* / per meter (max. 2 m)*
L690SBSW	ALUMINIUM SLIDING BASE M-LINE weiß / white**	2 m
L690SBSWZ	ALUMINIUM SLIDING BASE M-LINE weiß / white**	l _{fm} (max. 2 m)* / per meter (max. 2 m)*
L69GS3E	ALUMINIUM END CAP FLAT M-LINE CIRCLE	
L69GS3EW	ALUMINIUM END CAP FLAT M-LINE CIRCLE weiß / white**	
L69GC5E	ALUMINIUM END CAP OVAL M-LINE CIRCLE	
L69GC5EW	ALUMINIUM END CAP OVAL M-LINE CIRCLE weiß / white**	
L690006	ALUMINIUM SCHWENKHALTER silber 1 Stück ALUMINIUM SWIVELLING HOLDER silver 1 pcs	
L690006W	ALUMINIUM SCHWENKHALTER weiß** 1 Stück ALUMINIUM SWIVELLING HOLDER white** 1 pcs	
L69G001	ALUMINIUM PROFILE SET MOUNTING M-LINE CIRCLE Set bestehend aus: 3x Mounting Clip / Set includes: 3x Mounting Clip	
L69G001W	ALUMINIUM PROFILE SET MOUNTING M-LINE CIRCLE weiß / white** Set bestehend aus: 3x Mounting Clip / Set includes: 3x Mounting Clip	

*Zuschnitt nach Maß / Custom Length

** weiß RAL 9016 / white RAL 9016

PROLED®

1.2



Eine Übersicht welche PROFILE mit welchen STRIPS kompatibel sind, finden Sie auf Seite 250.

For compatibility of PROFILES and STRIPS see page 250.

proled.com

PLASTIC COVERS M-LINE Seite 216-218 / page 216-218

Formen shapes	Varianten versions
FLAT	CLEAR, FROST, MILKY (OPAL), BLACK
BREAK-PROOF FLAT	CLEAR, FROST, MILKY (OPAL)
OVAL	CLEAR, FROST, MILKY (OPAL)
ROUND	CLEAR, FROST, MILKY (OPAL)
SQUARE	CLEAR, FROST, MILKY (OPAL)

PLASTIC COVERS M-LINE



FLAT COVER

OVAL COVER

ROUND COVER

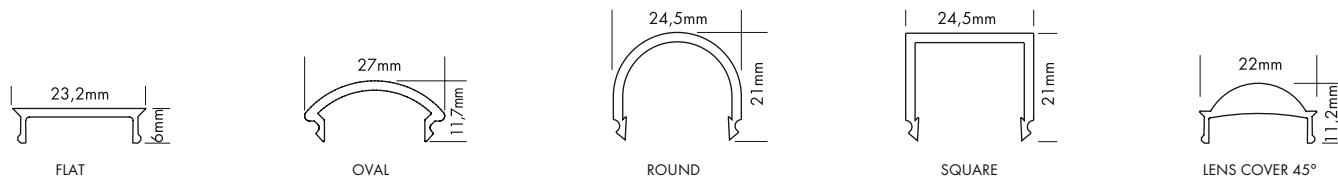

M-LINE KUNSTSTOFFABDECKUNGEN

Vier verschiedene Formen von hochwertigen Kunststoffabdeckungen stehen zur Verfügung:

- plane Abdeckung
- ovale Abdeckung
- halbrunde Abdeckung
- eckige Abdeckung

Jede der vier Formen ist in folgenden Varianten erhältlich:

- glasklar
- frost (halbkklar)
- milchig frost (opal)
- schwarz (siehe Seite 218)

Die plane Abdeckung (FLAT) ist auch als begehbare und bruchfeste Variante (BREAK-PROOF) in glasklar, frost, milchig frost (opal) erhältlich.

LENS COVER 45°

Mit dem LENS COVER wird eine Bündelung und somit ein engerer Abstrahlwinkel erzeugt. Je nach Abstand zwischen FLEX STRIP und LENS COVER ist der Abstrahlwinkel max. 45°.



M-LINE PLASTIC COVERS

Four different shapes of high quality plastic covers are available:

- flat cover
- oval cover
- round cover
- square cover

Each of the four shapes are available in following versions:

- crystal clear
- frost (semitransparent)
- milky frost (opal)
- black (see page 218)

The flat cover (FLAT) is also as a walkable and break-proof version in crystal clear, frost, milky frost (opal) available.

LENS COVER 45°

The LENS COVER provides a concentration of light rays and therefore a narrower beam angle. Depending on the distance between FLEX STRIP and LENS COVER the max. beam angle is 45°.



Clear

Frost

Milky (opal)

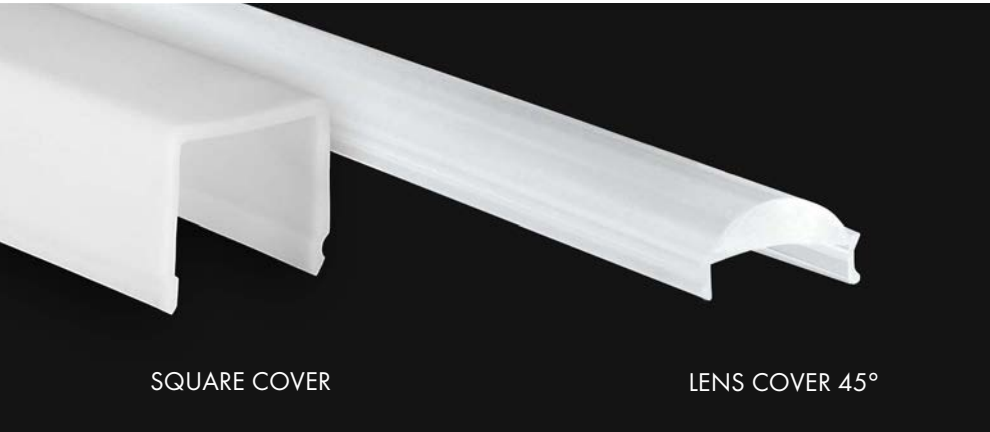

SQUARE COVER

LENS COVER 45°



KOMPATIBILITÄT MIT PROFILEN
COMPATIBILITY WITH PROFILES

M-LINE

	EXTRA LOW 10	EXTRA LOW 24	LOW	STANDARD	STANDARD 24	REC	REC 24	REC 24 ST	GRID	CORNER	DRYWALL LINEAR	DRYWALL CORNER INTERNAL	DRYWALL CORNER EXTERNAL	H	2W	3W	CIRCLE
L690S3C	X	X	X	X	X	X	X	X	X	X	X	X	X	X	X	X	X
L690S3CX	X	X	X	X	X	X	X	X	X	X	X	X	X	X	X	X	X
L690S3CY	X	X	X	X	X	X	X	X	X	X	X	X	X	X	X	X	X
L690S3CZ	X	X	X	X	X	X	X	X	X	X	X	X	X	X	X	X	X
L690S3F	X	X	X	X	X	X	X	X	X	X	X	X	X	X	X	X	X
L690S3FX	X	X	X	X	X	X	X	X	X	X	X	X	X	X	X	X	X
L690S3FY	X	X	X	X	X	X	X	X	X	X	X	X	X	X	X	X	X
L690S3FZ	X	X	X	X	X	X	X	X	X	X	X	X	X	X	X	X	X
L690S3M	X	X	X	X	X	X	X	X	X	X	X	X	X	X	X	X	X
L690S3MX	X	X	X	X	X	X	X	X	X	X	X	X	X	X	X	X	X
L690S3MY	X	X	X	X	X	X	X	X	X	X	X	X	X	X	X	X	X
L690S3MZ	X	X	X	X	X	X	X	X	X	X	X	X	X	X	X	X	X
L690S3CB	X	X	X	X	X	X	X	X	X	X	X	X	X	X	X	X	X
L690S3CBX	X	X	X	X	X	X	X	X	X	X	X	X	X	X	X	X	X
L690S3CBy	X	X	X	X	X	X	X	X	X	X	X	X	X	X	X	X	X
L690S3CBZ	X	X	X	X	X	X	X	X	X	X	X	X	X	X	X	X	X
L690S3FB	X	X	X	X	X	X	X	X	X	X	X	X	X	X	X	X	X
L690S3FBX	X	X	X	X	X	X	X	X	X	X	X	X	X	X	X	X	X
L690S3FBy	X	X	X	X	X	X	X	X	X	X	X	X	X	X	X	X	X
L690S3FBZ	X	X	X	X	X	X	X	X	X	X	X	X	X	X	X	X	X
L690S3MB	X	X	X	X	X	X	X	X	X	X	X	X	X	X	X	X	X
L690S3MBX	X	X	X	X	X	X	X	X	X	X	X	X	X	X	X	X	X
L690S3MBy	X	X	X	X	X	X	X	X	X	X	X	X	X	X	X	X	X
L690S3MBZ	X	X	X	X	X	X	X	X	X	X	X	X	X	X	X	X	X
L690V4C	X	X	X	X	X	X	X	X	X	X	X	X	X	X	X	X	X
L690V4CX	X	X	X	X	X	X	X	X	X	X	X	X	X	X	X	X	X
L690V4CZ	X	X	X	X	X	X	X	X	X	X	X	X	X	X	X	X	X
L690V4F	X	X	X	X	X	X	X	X	X	X	X	X	X	X	X	X	X
L690V4FX	X	X	X	X	X	X	X	X	X	X	X	X	X	X	X	X	X
L690V4FZ	X	X	X	X	X	X	X	X	X	X	X	X	X	X	X	X	X
L690V4M	X	X	X	X	X	X	X	X	X	X	X	X	X	X	X	X	X
L690V4MX	X	X	X	X	X	X	X	X	X	X	X	X	X	X	X	X	X
L690V4MZ	X	X	X	X	X	X	X	X	X	X	X	X	X	X	X	X	X
L690R2C	X	X	X	X	X	X	X	X	X	X	X	X	X	X	X	X	X
L690R2CX	X	X	X	X	X	X	X	X	X	X	X	X	X	X	X	X	X
L690R2CZ	X	X	X	X	X	X	X	X	X	X	X	X	X	X	X	X	X
L690R2F	X	X	X	X	X	X	X	X	X	X	X	X	X	X	X	X	X
L690R2FX	X	X	X	X	X	X	X	X	X	X	X	X	X	X	X	X	X
L690R2FZ	X	X	X	X	X	X	X	X	X	X	X	X	X	X	X	X	X
L690R2M	X	X	X	X	X	X	X	X	X	X	X	X	X	X	X	X	X
L690R2MX	X	X	X	X	X	X	X	X	X	X	X	X	X	X	X	X	X
L690R2MZ	X	X	X	X	X	X	X	X	X	X	X	X	X	X	X	X	X
L690S1C	X	X	X	X	X	X	X	X	X	X	X	X	X	X	X	X	X
L690S1CX	X	X	X	X	X	X	X	X	X	X	X	X	X	X	X	X	X
L690S1CZ	X	X	X	X	X	X	X	X	X	X	X	X	X	X	X	X	X
L690S1F	X	X	X	X	X	X	X	X	X	X	X	X	X	X	X	X	X
L690S1FX	X	X	X	X	X	X	X	X	X	X	X	X	X	X	X	X	X
L690S1FZ	X	X	X	X	X	X	X	X	X	X	X	X	X	X	X	X	X
L690S1M	X	X	X	X	X	X	X	X	X	X	X	X	X	X	X	X	X
L690S1MX	X	X	X	X	X	X	X	X	X	X	X	X	X	X	X	X	X
L690S1MZ	X	X	X	X	X	X	X	X	X	X	X	X	X	X	X	X	X
L690L45C	X	X	X	-	-	-	-	-	-	X	-	-	-	X	-	-	-
L690L45CX	X	X	X	-	-	-	-	-	-	X	-	-	-	X	-	-	-
L690L45CZ	X	X	X	-	-	-	-	-	-	X	-	-	-	X	-	-	-

* Zuschnitt nach Maß / Custom Length

1.2

PLASTIC COVER M-LINE BLACK

PROLED

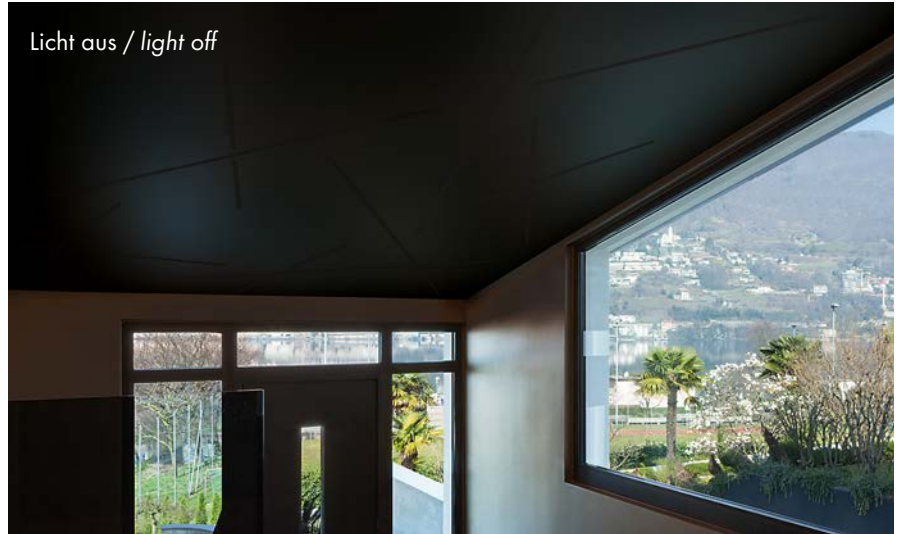
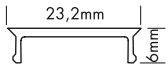

5 Years

SEE PAGE 4

M-LINE KUNSTSTOFFABDECKUNG SCHWARZ

Mit dem PROLED PLASTIC COVER BLACK stehen Ihnen weitere Designmöglichkeiten für lineare Lichtanwendungen in Verbindung mit den PROLED ALUMINIUM PROFILEN in schwarz zur Verfügung. Im ausgeschalteten Zustand ist das PROLED PLASTIC COVER BLACK komplett schwarz. Sobald der LED Streifen eingeschaltet wird, verwandelt sich die schwarze Linie in eine illuminierte Linie.

M-LINE PLASTIC COVER BLACK

With the PROLED PLASTIC COVER BLACK we offer you more design possibilities for linear lighting designs together with the PROLED ALUMINIUM PROFILES. If the light is switched off the PROLED PLASTIC COVER BLACK is totally black. If you switch on the LED strip the black line changes to an illuminated line.

Produkttypen / Product Type

Artikel-Nr. order code	Bezeichnung description	Länge length
L690S3B	PLASTIC COVER M-LINE FLAT BLACK	2 m
L690S3BX	PLASTIC COVER M-LINE FLAT BLACK	3 m
L690S3BZ	PLASTIC COVER M-LINE FLAT BLACK	lfm (max. 3 m)* / per meter (max. 3 m)*

*Zuschnitt nach Maß / Custom Length